

Alternative top caps

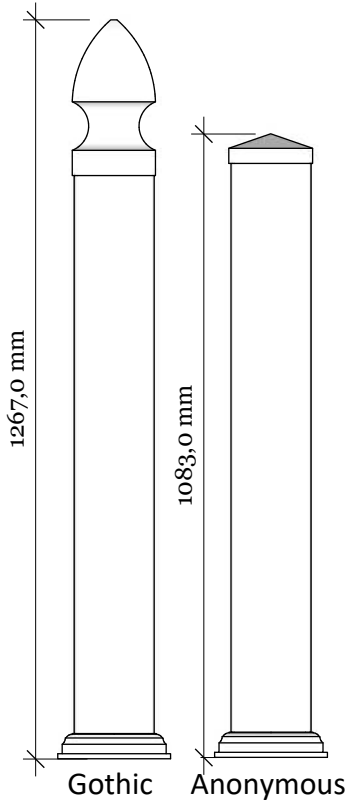

FD-4 Gard PLUS 90 with New England top

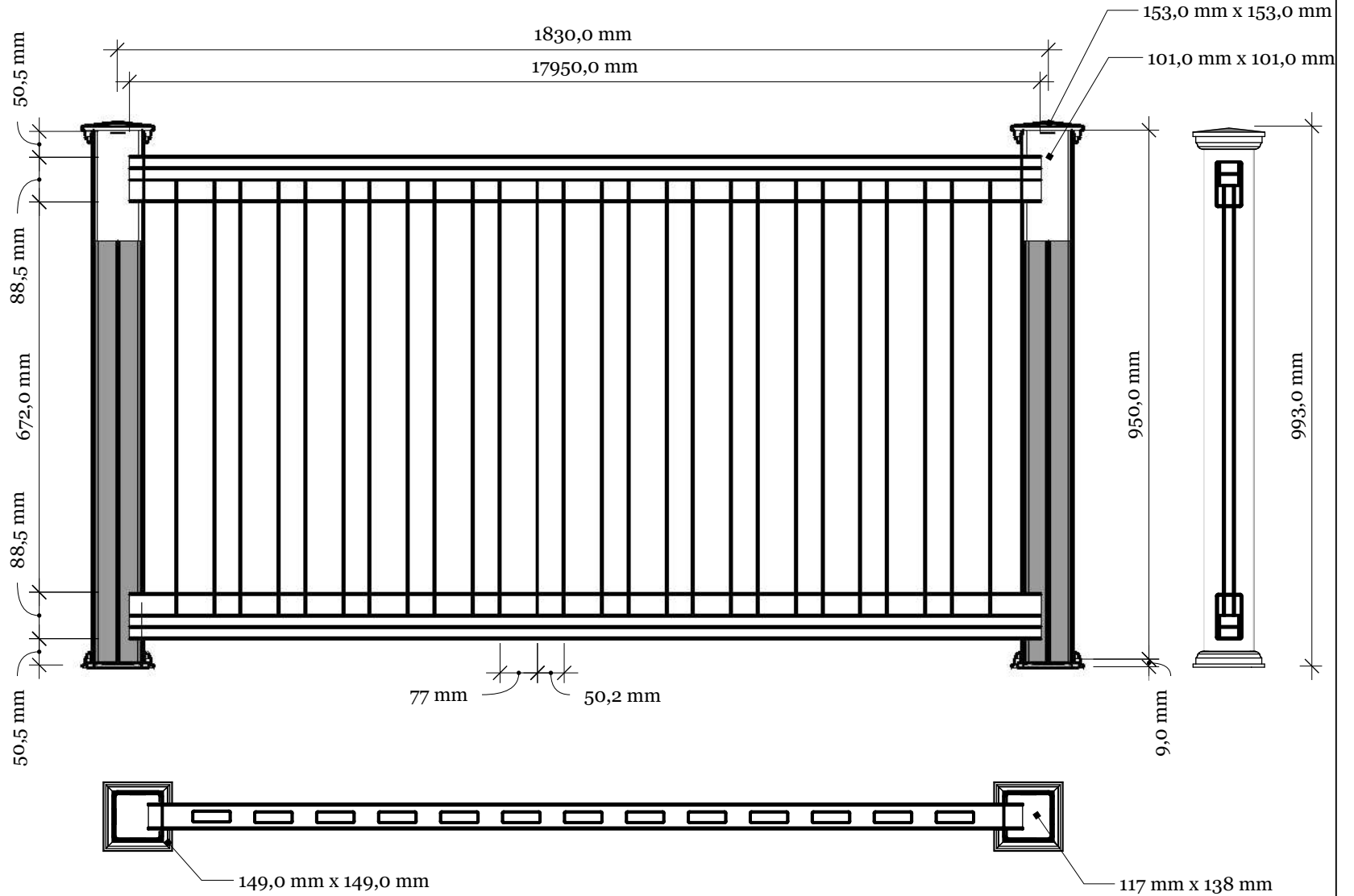

Revisions		
	MM/DD/YY	Notes
1	14/11/17	Sheet Production - RL
2	06/10/20	Name definition, and layout update - MS
3	10/02/21	Layout update - RL
4	02/02/23	Layout update - LMS
5	--/--/--	...

# FD-4 Gard PLUS 90 railing with New England top

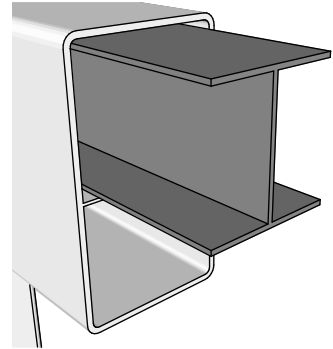

Top rail profile

Rigid aluminum insert in post

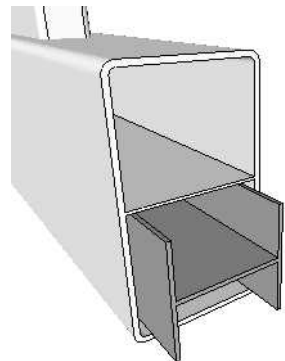
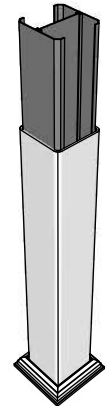

Aluminum profile in bottom rail to prevent deflection

Post  
101mm x 101mm

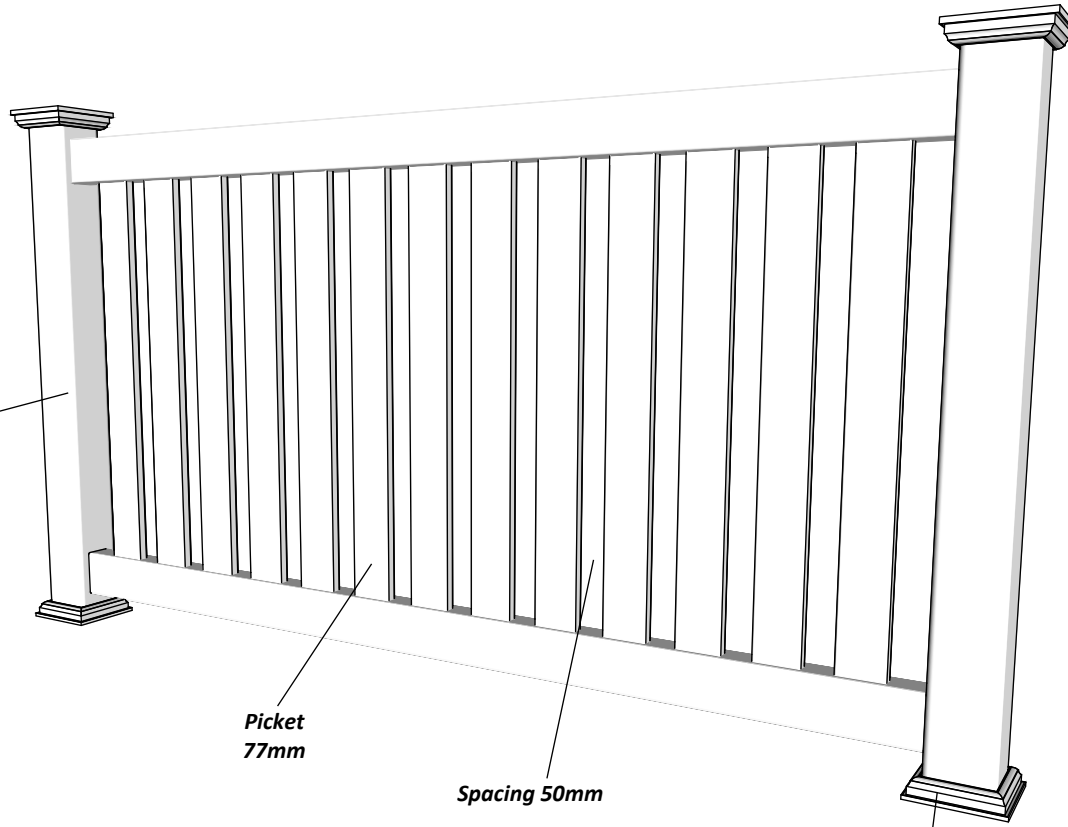

Picket  
77mm

Spacing 50mm

Bottom cover  
174mm x 174mm.

Bottom of insert is  
123mm x 123mm  
8mm thickness of alu

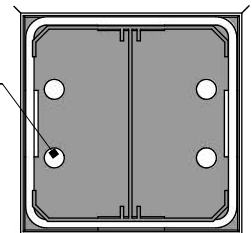

Dia = 12mm



**FD-4 Gard PLUS 90**

[www.kystgjerdet.com](http://www.kystgjerdet.com)

Revisions		
	MM/DD/YY	Notes
1	14/11/17	Sheet Production - RL
2	06/10/20	Name definition, and layout update - MS
3	10/02/21	Layout update - RL
4	02/02/23	Layout update - LMS
5	--/--/--	...

**A 04**

**Alt. for component 1:**

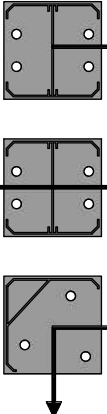

Art. No: 102309

Art. No: 102309

Art. No: 102310

---

**Alt. for component 2:**



Line Post: Art. No: 102137  
For pack no: 2306

End Post: Art. No: 102138  
For pack no: 2307

Corner Post: Art. No: 102139  
For pack no: 2308

Special Post: Art. No: 102140  
For pack no: 2309

## Component overview for pack no: 2306-2309

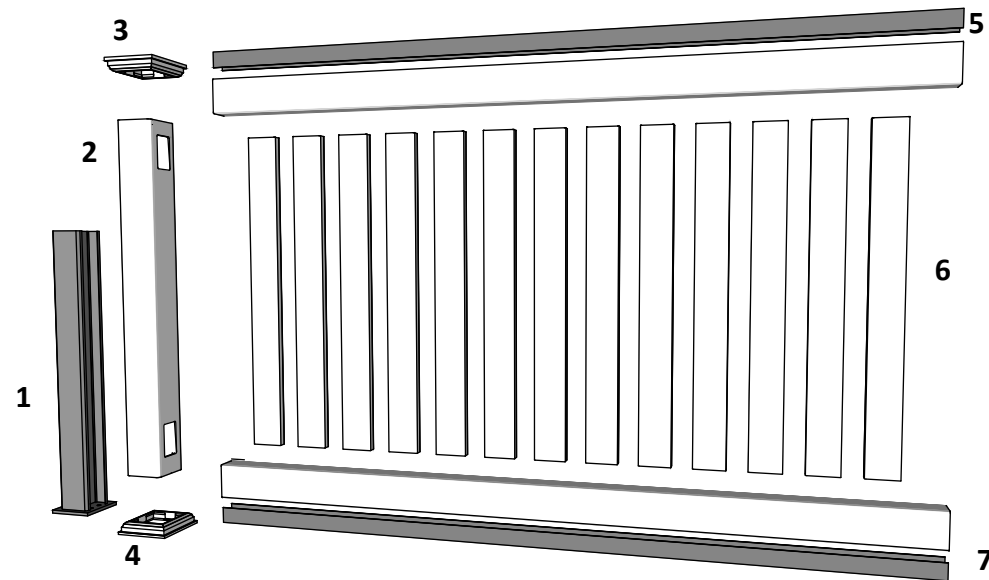

**1 full section contains:**

1. Aluminum insert for post	- Art. No: See alternatives
2. PVC post	- Art. No: See alternatives
3. New England top (as standard)	- Art. No: 102404
4. Bottom cover	- Art. No: 102450
5. Top rail	- Art. No: 100105
6. 13 Pickets	- Art. No: 102018
7. Bottom rail with alu. liner	- Art. No: 100105

Additional posts can be purchased separately:

Line Post - Pack no: 8890

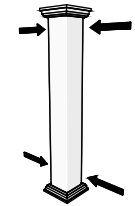

End Post - Pack no: 8887

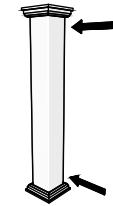

Corner Post - Pack no: 8888

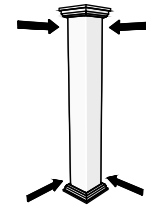

Special Post - Pack no: 8889



Revisions		
1	14/11/17	Sheet Production - RL
2	06/10/20	Name definition, and layout update - MS
3	10/02/21	Layout update - RL
4	02/02/23	Layout update - LMS
5	---/---/---	...