

Alternative top caps

FD-1 Royal 100 with New England top

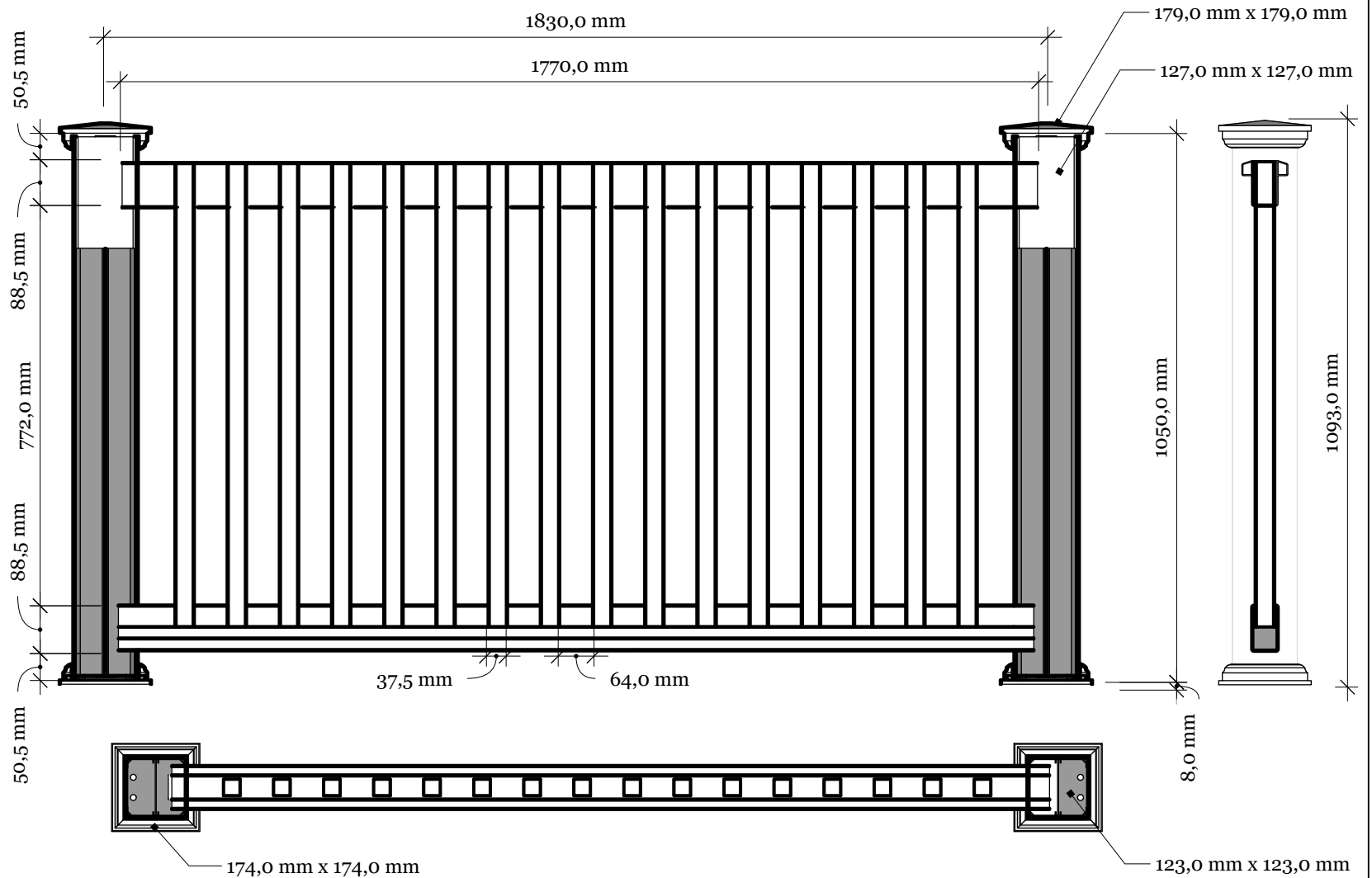
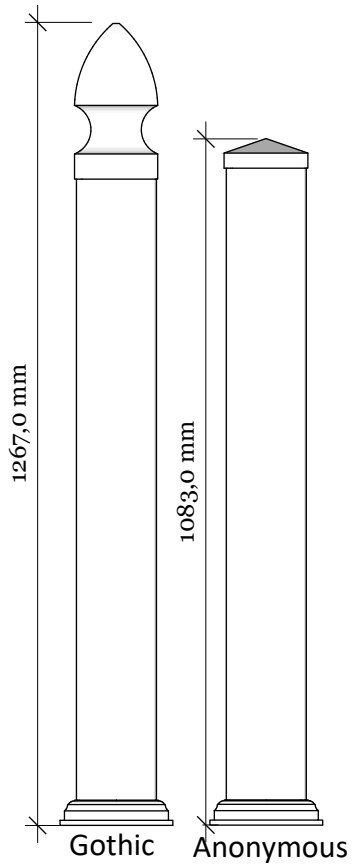

FD-1 Royal 100
www.kystgjerdet.com

Revisions		
	MM/DD/YY	Notes
1	14/11/17	Sheet Production - RL
2	06/10/20	Name definition, and layout update - MS
3	10/02/21	Layout update - RL
4	--/--/--	...
5	--/--/--	...

A 03

FD-1 Royal 100 railing with New England top

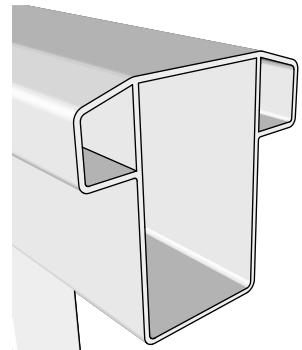

Top rail profile

Rigid aluminum insert in post

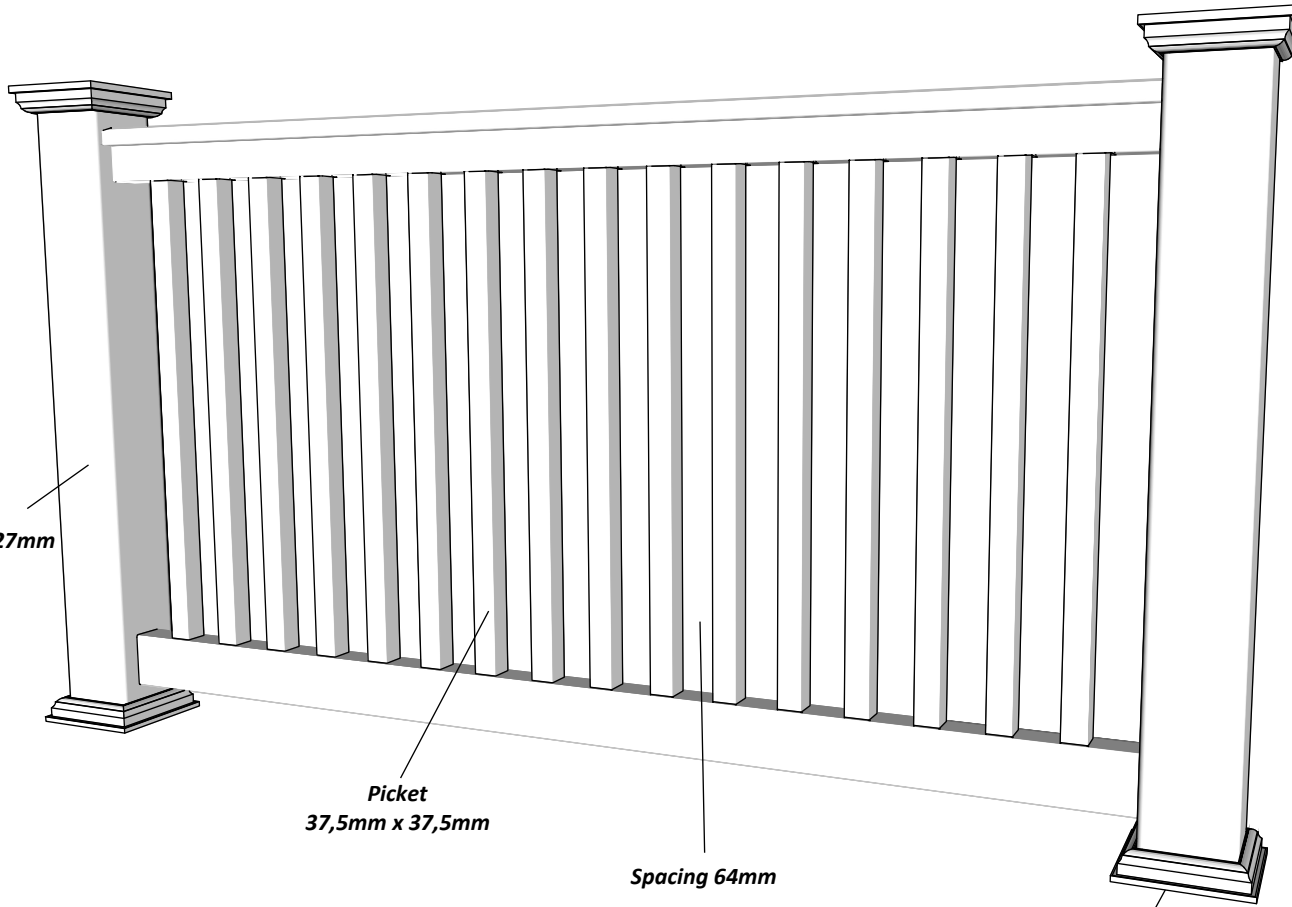
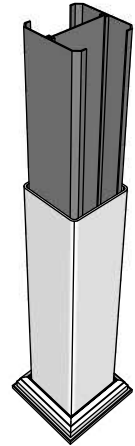

Post
127mm x 127mm

Picket
37,5mm x 37,5mm

Spacing 64mm

Bottom of insert is
123mm x 123mm
8mm thickness of alu

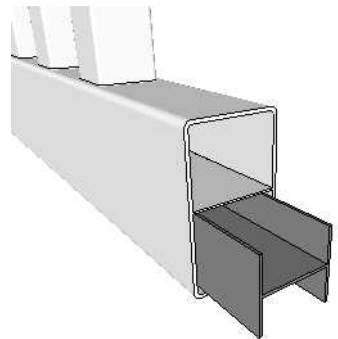

Aluminum profile in
bottom rail to prevent
deflection

Bottom cover
174mm x 174mm.

Dia = 12mm

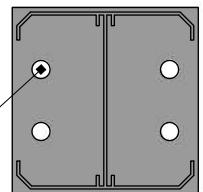

KYSTGJERDET

FD-1 Royal 100
www.kystgjerdet.com

Revisions		
	MM/DD/YY	Notes
1	14/11/17	Sheet Production - RL
2	06/10/20	Name definition, and layout update - MS
3	10/02/21	Layout update - RL
4	--/--/--	...
5	--/--/--	...

A 03

Alt. for component 1:

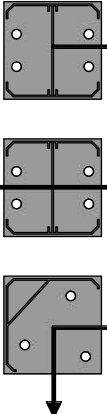

Art. No: 102300

Art. No: 102300

Art. No: 102303

Alt. for component 2:



Line Post: Art. No: 100806
For pack no: 1011

End Post: Art. No: 100807
For pack no: 1012

Corner Post: Art. No: 100808
For pack no: 1013

Special Post: Art. No: 100809
For pack no: 1014

Component overview for pack no: 1011-1014

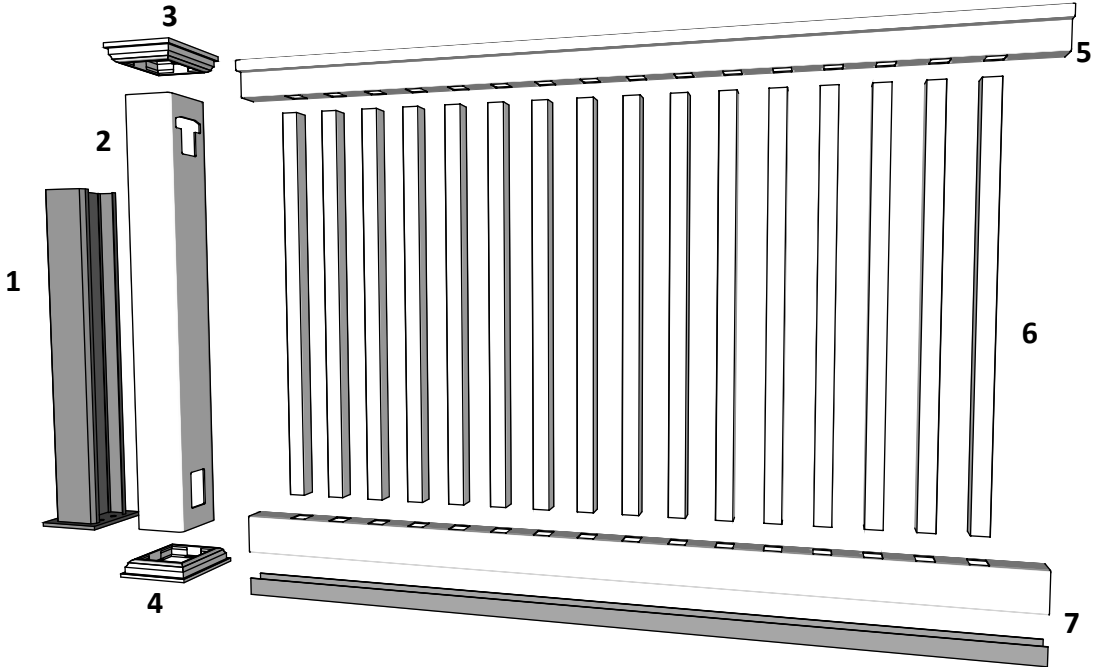

1 full section contains:

1. Aluminum insert for post	- Art. No: See alternatives
2. PVC post	- Art. No: See alternatives
3. New England top (as standard)	- Art. No: 102457
4. Bottom cover	- Art. No: 102449
5. Top rail	- Art. No: 100001
6. 16 Pickets	- Art. No: 101603
7. Bottom rail with alu. liner	- Art. No: 100101

Additional posts can be purchased separately:

Line Post - Pack no: 8606

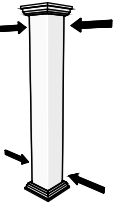

End Post - Pack no: 8607

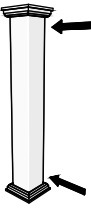

Corner Post - Pack no: 8608

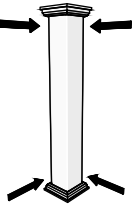

Special Post - Pack no: 8803

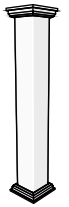

Revisions		
1	14/11/17	Sheet Production - RL
2	06/10/20	Name definition, and layout update - MS
3	10/02/21	Layout update - RL
4	02/02/23	Layout update - LMS
5	--/--/--	...