

Alternative top caps

FD-1 Prima 90 with New England top

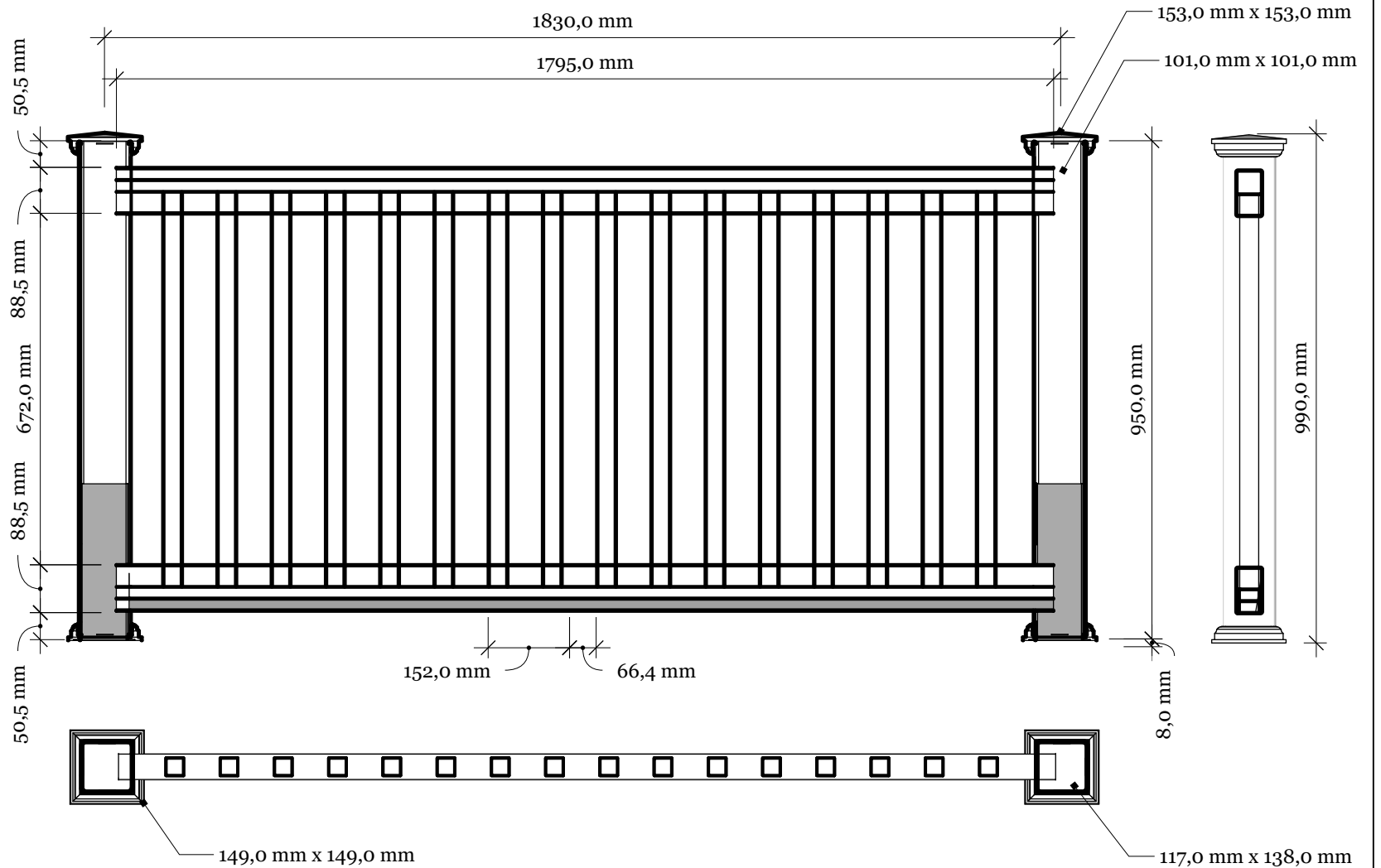
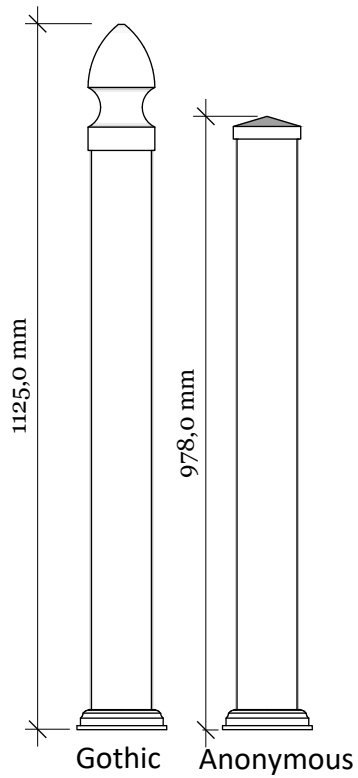

FD-1 Prima 90
www.kystgjerdet.com

Revisions		
	MM/DD/YY	Notes
1	14/11/17	Sheet Production - RL
2	06/10/20	Name definition, and layout update - MS
3	10/02/21	Layout update - RL
4	---/---/---	...
5	---/---/---	...

A 03

FD-1 Prima 90 railing with New England top

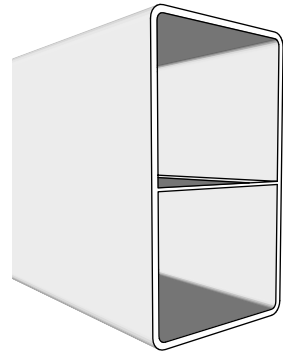

Top rail profile

30cm galvanized steel insert for posts.

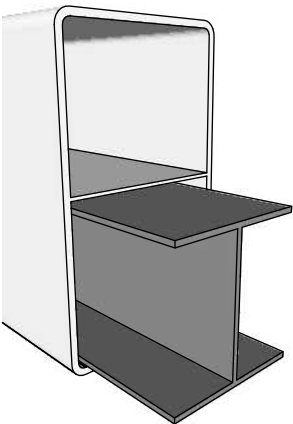
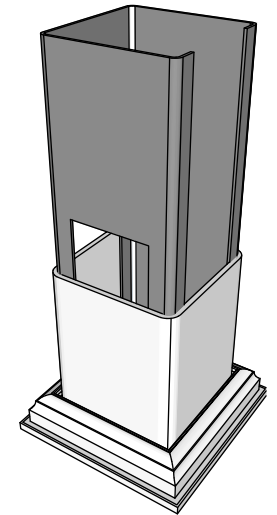

Aluminum profile in bottom rail to prevent deflection

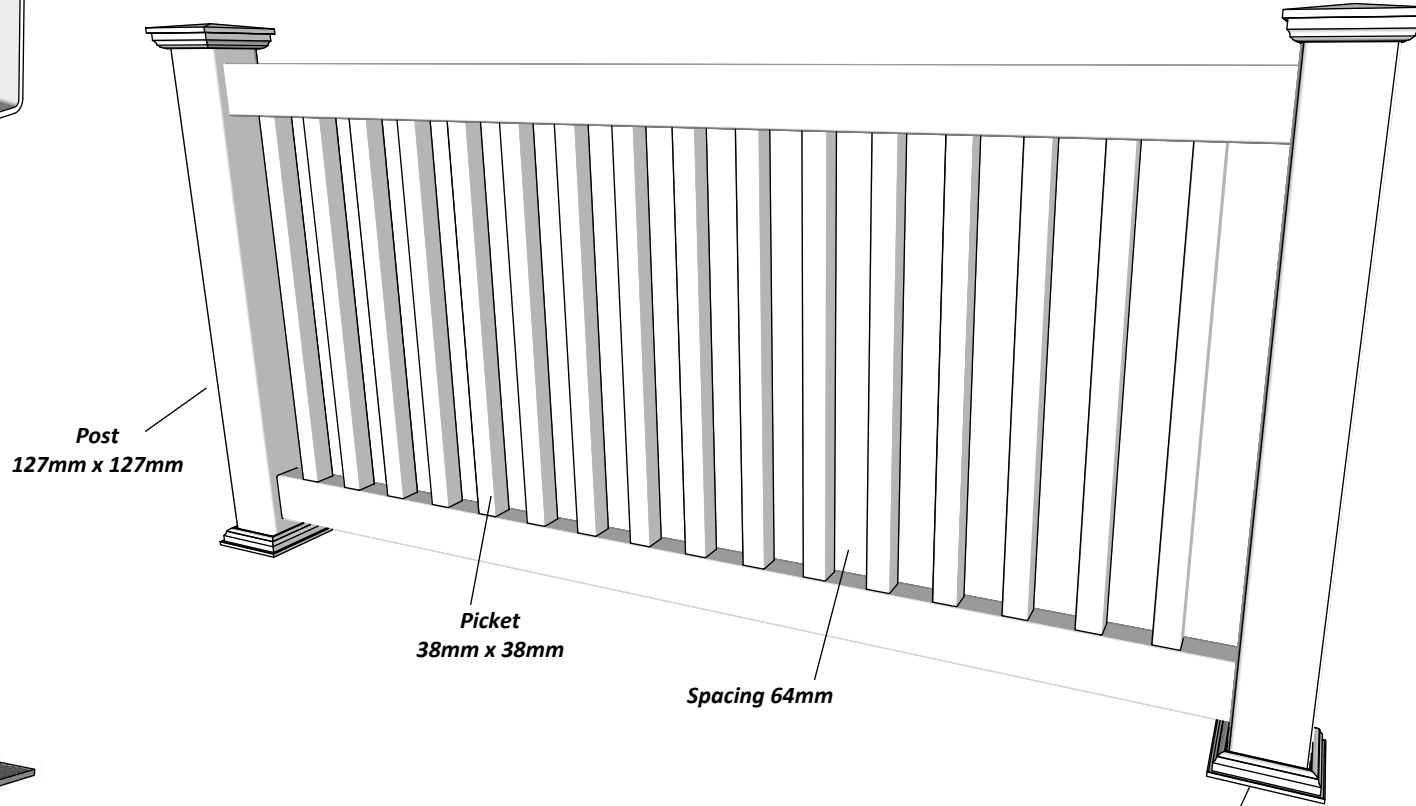

Bottom of insert is 117mm x 138mm. 2mm thickness of steel.

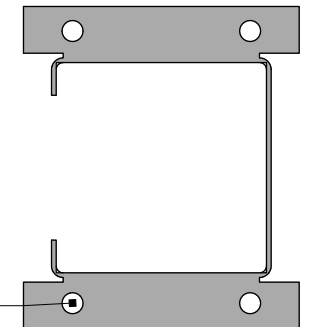

Dia = 9mm



FD-1 Prima 90
www.kystgjerdet.com

Revisions		
	MM/DD/YY	Notes
1	14/11/17	Sheet Production - RL
2	06/10/20	Name definition, and layout update - MS
3	10/02/21	Layout update - RL
4	---/---/---	...
5	---/---/---	...

A 03

Component 1:

Art. No: 102311

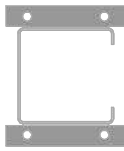

Alt. for component 2:

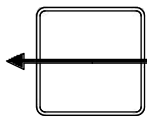
 **Line Post: Art. No: 102100**
For pack no: 2000

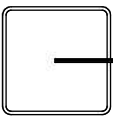
 **End Post: Art. No: 102101**
For pack no: 2001

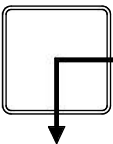
 **Corner Post: Art. No: 102102**
For pack no: 2002

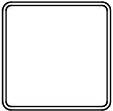
 **Special Post: Art. No: 102120**
For pack no: 2003

Component overview for pack no: 2000-2003

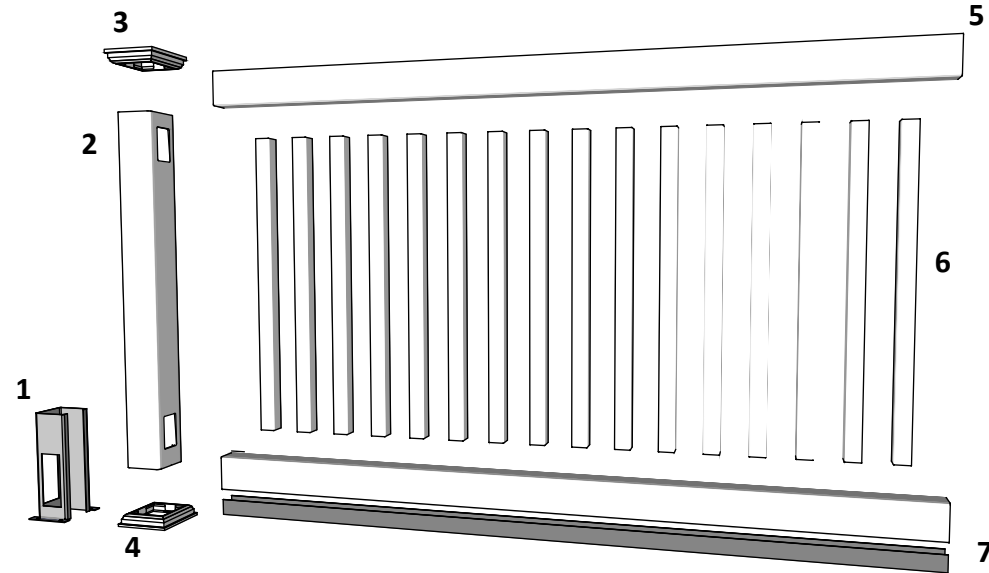

1 full section contains:

1. Steel insert for post	- Art. No: 102311
2. PVC post	- Art. No: See alternatives
3. New England top (as standard)	- Art. No: 102404
4. Bottom cover	- Art. No: 102450
5. Top rail	- Art. No: 100214
6. 13 Pickets	- Art. No: 102018
7. Bottom rail with alu. liner	- Art. No: 100107

Additional posts can be purchased separately:

Line Post - Pack no: 8845

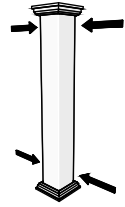

End Post - Pack no: 8846

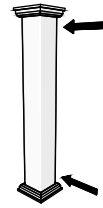

Corner Post - Pack no: 8847

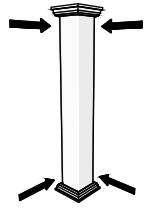

Special Post - Pack no: 8849

