

Alternative top caps

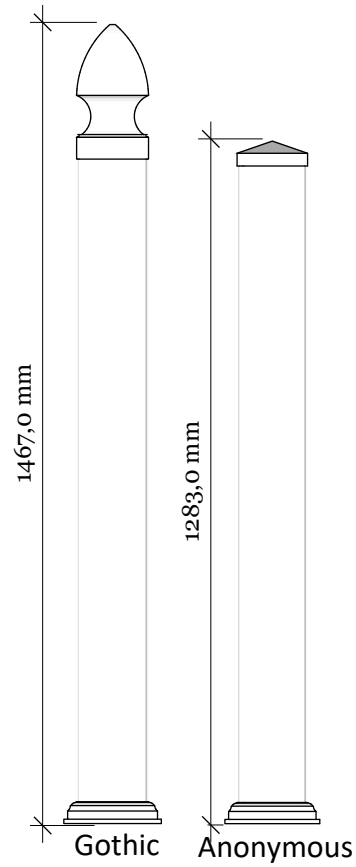

FD-1G Royal 120 Grey with New England top

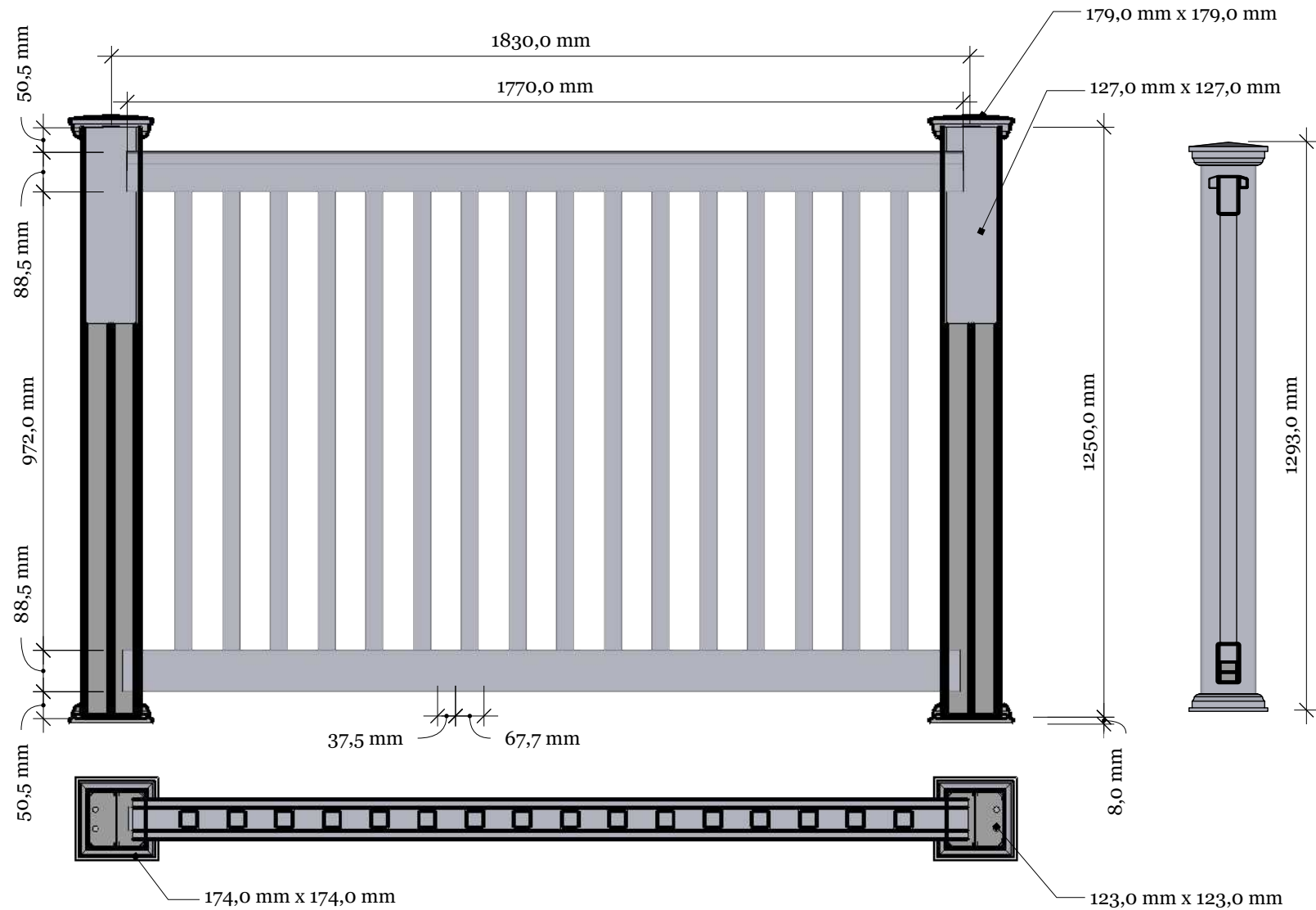

FD-1G Royal Grey 120

www.kystgjerdet.com

Revisions

	MM/DD/YY	Notes
1	14/11/17	Sheet Production - RL
2	06/10/20	Name definition, and layout update - MS
3	10/02/21	Layout update - RL
4	--/--/--	...
5	--/--/--	...

03

A

FD-1G Royal 120 Grey railing with New England top

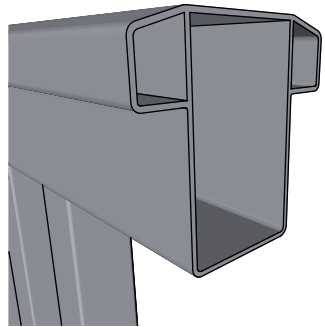

Top rail profile

Rigid aluminum insert in post

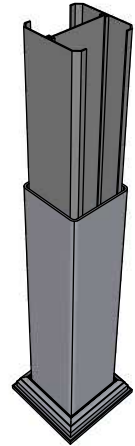

Post
127mm x 127mm

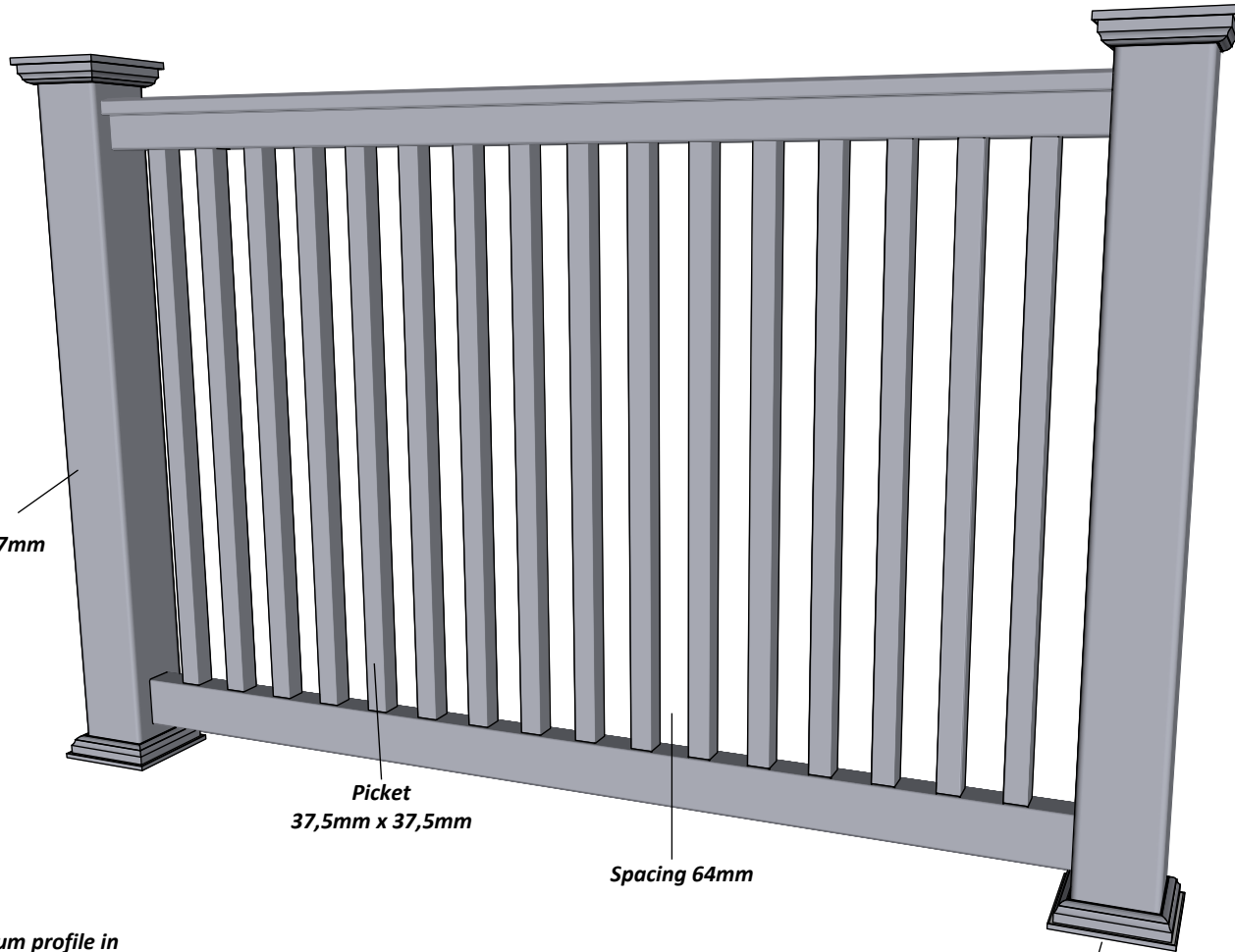

Picket
37,5mm x 37,5mm

Spacing 64mm

Bottom of insert is
123mm x 123mm
8mm thickness of alu

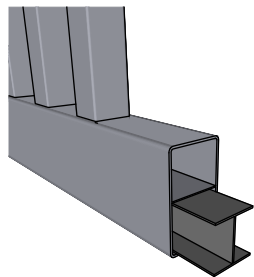

Aluminum profile in
bottom rail to prevent
deflection

Bottom cover
174mm x 174mm.

Ø = 12mm

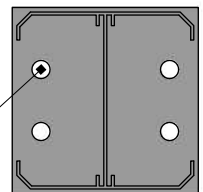

KYSTGJERDET

FD-1G Royal Grey 120

www.kystgjerdet.com

Revisions

	MM/DD/YY	Notes
1	14/11/17	Sheet Production - RL
2	06/10/20	Name definition, and layout update - MS
3	10/02/21	Layout update - RL
4	___/___/___	...
5	___/___/___	...

A 03

A

Alt. for component 1:

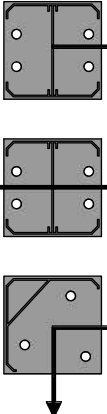

Art. No: 102300

Art. No: 102300

Art. No: 102303

Alt. for component 2:



Line Post: Art. No: 100831
For pack no: 1322

End Post: Art. No: 100832
For pack no: 1323

Corner Post: Art. No: 100833
For pack no: 1324

Special Post: Art. No: 100522
For pack no: 1325

Component overview for pack no: 1322-1325

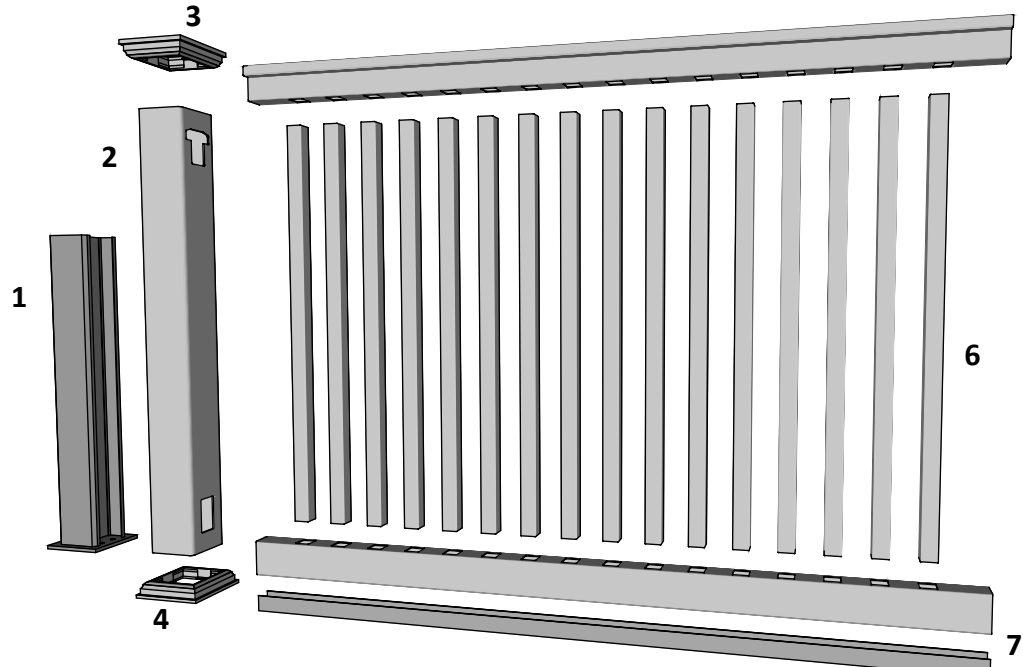

1 full section contains:

1. Aluminum insert for post	- Art. No: See alternatives
2. PVC post	- Art. No: See alternatives
3. New England top (if not specified)	- Art. No: 102465
4. Bottom cover	- Art. No: 102451
5. Top rail	- Art. No: 100023
6. 16 Pickets	- Art. No: 101607
7. Bottom rail with alu. liner	- Art. No: 100118

Additional posts can be purchased separately:

Line Post - Pack no: 8631

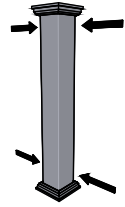

End Post - Pack no: 8632

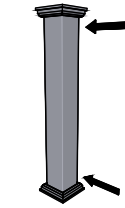

Corner Post - Pack no: 8633

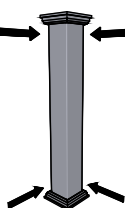

Special Post - Pack no: 8834

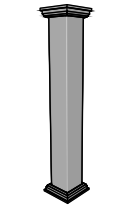

FD-1 Royal Grey 120

www.kystgjerdet.com

Revisions		
1	14/11/17	Sheet Production - RL
2	06/10/20	Name definition, and layout update - MS
3	10/02/21	Layout update - RL
4	02/02/23	Layout update - LMS
5	---/---/---	...

A 04