

Alternative top caps

FD-12 Kystgjerdet 100 with New England top

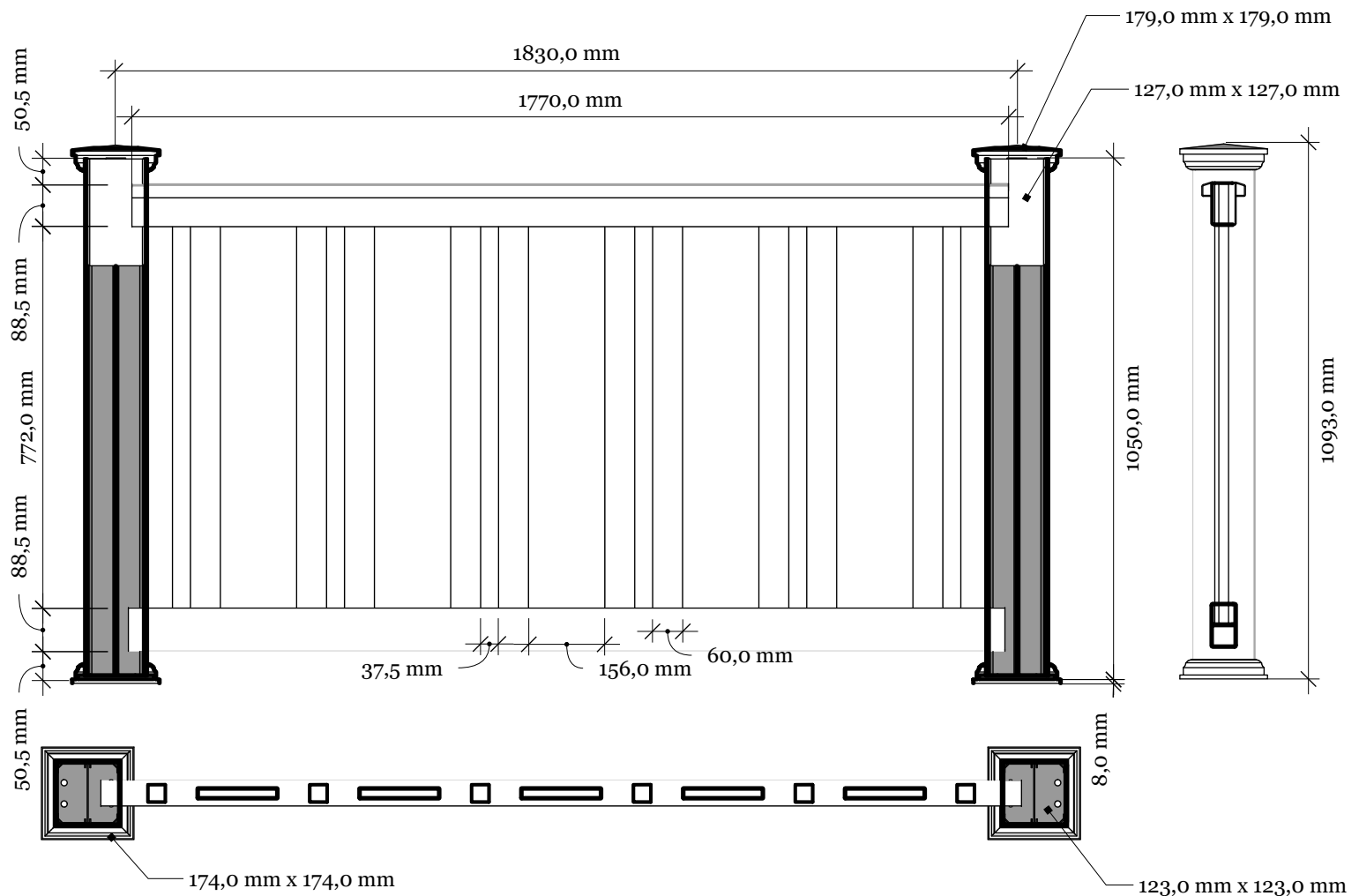
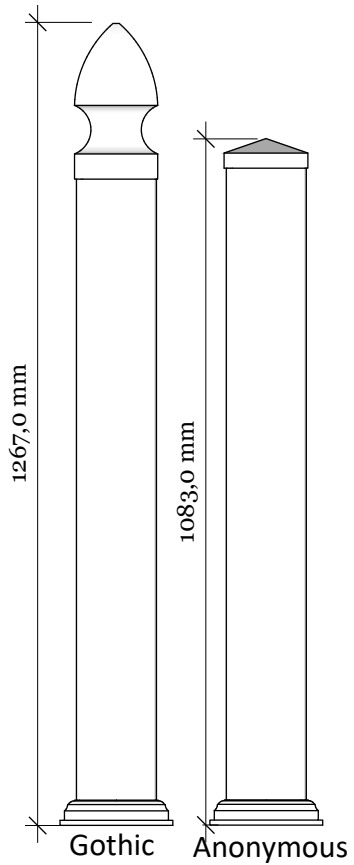

FD-12 Kystgjerdet 100

www.kystgjerdet.com

Revisions

No.	Date	Description
1	14/11/17	Sheet Production - RL
2	06/10/20	Name definition, and layout update - MS
3	10/02/21	Layout update - RL
4	---/---/---	...
5	---/---/---	...

A 03

A

FD-12 Kystgjerdet PLUS 100 railing with New England topp

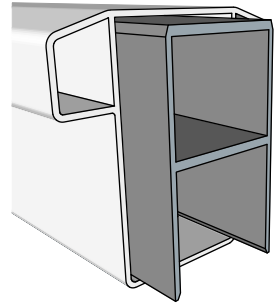

Top rail profile

Rigid aluminum insert in post

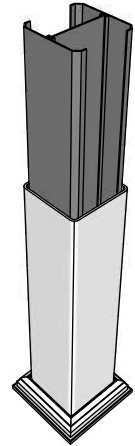

Post
127mm x 127mm

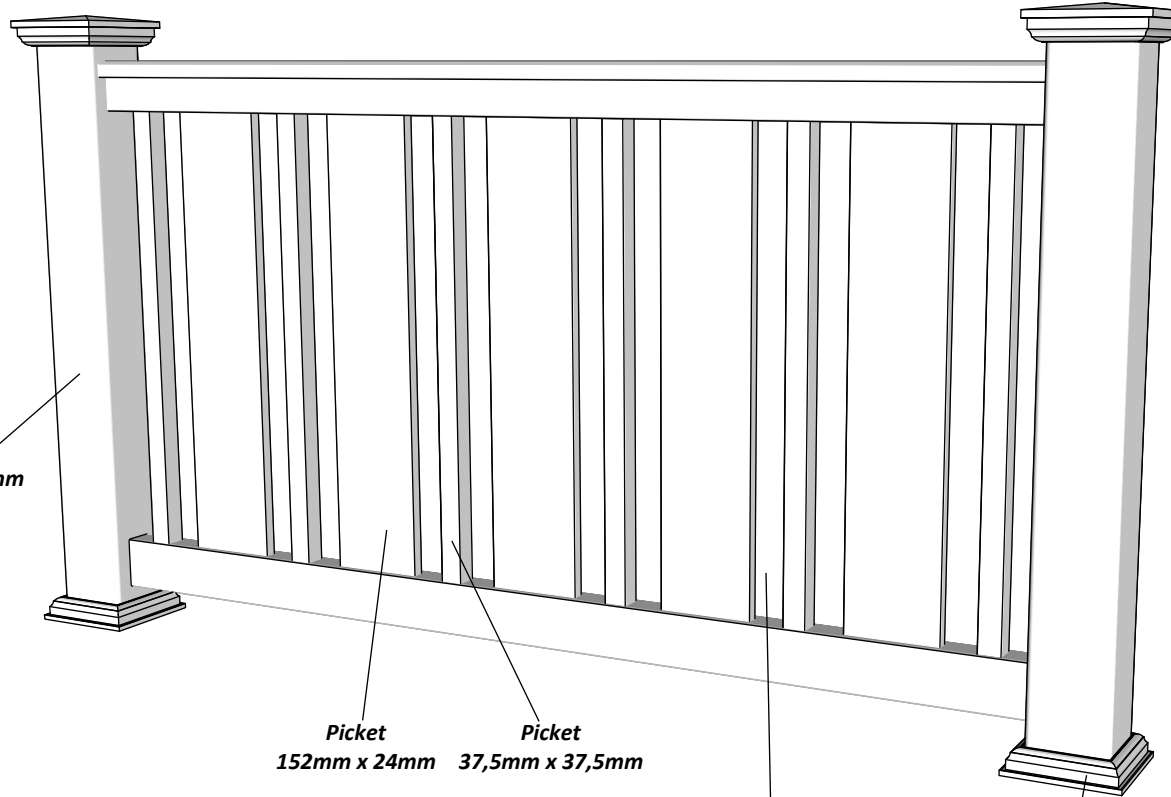

Picket
152mm x 24mm Picket
37,5mm x 37,5mm

Spacing 60mm

Bottom of insert is
123mm x 123mm
8mm thickness of alu

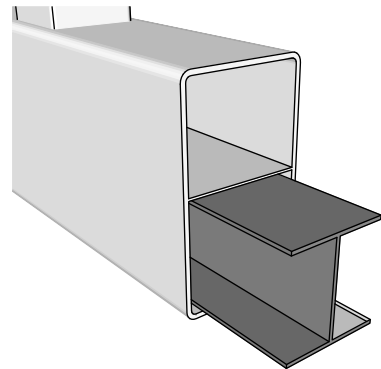

Aluminum profile in
bottom rail to prevent
deflection

Bottom cover
174mm x 174mm.

Dia = 12mm

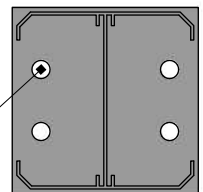

KYSTGJERDET

FD-12 Kystgjerdet PLUS 100

www.kystgjerdet.com

Revisions

Rev	Date	Description
1	14/11/17	Sheet Production - RL
2	06/10/20	Name definition, and layout update - MS
3	10/02/21	Layout update - RL
4	___/___/___	...
5	___/___/___	...

03

A

Alt. for component 1:

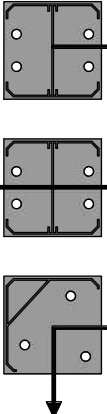

Art. No: 102300

Art. No: 102300

Art. No: 102303

Alt. for component 2:



Line Post: Art. No: 100806
For pack no: 1706

End Post: Art. No: 100807
For pack no: 1707

Corner Post: Art. No: 100808
For pack no: 1708

Special Post: Art. No: 101502
For pack no: 1709

Component overview for pack no: 1706-1709

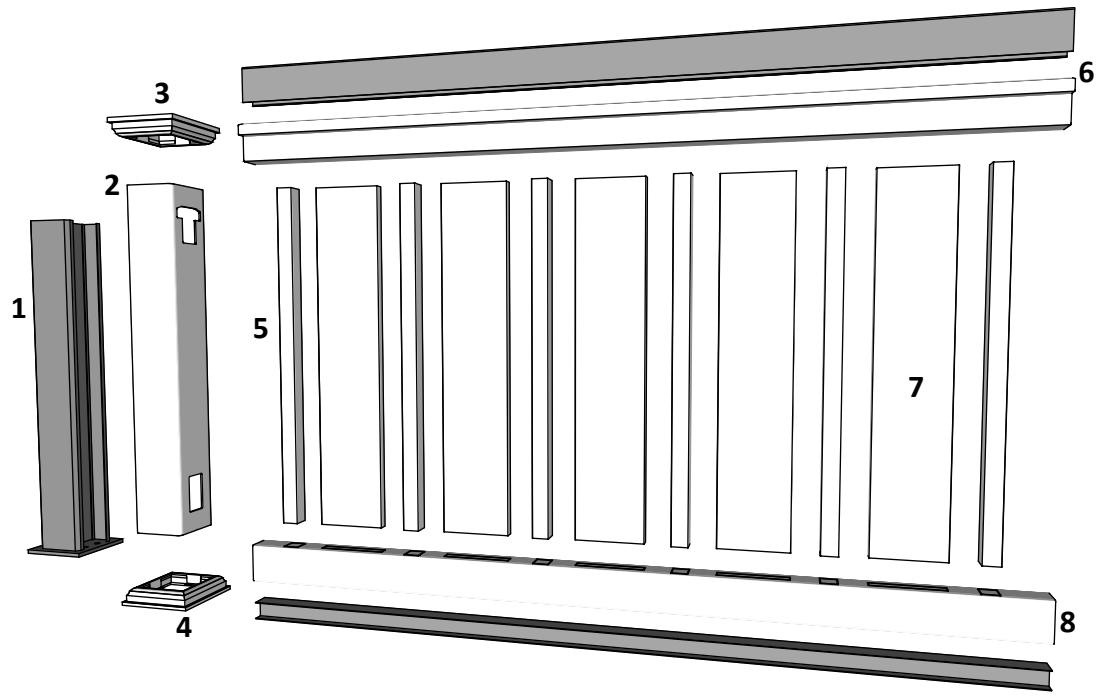

1 full section contains:

1. Aluminum insert for post	- Art. No: See alternatives
2. PVC post	- Art. No: See alternatives
3. New England top (if not specified)	- Art. No: 102457
4. Bottom cover	- Art. No: 102449
5. 6 Pickets	- Art. No: 100602
6. Top rail	- Art. No: 100078
7. 5 Pickets	- Art. No: 101742
8. Bottom rail with alu. liner	- Art. No: 100103

Additional posts can be purchased separately:

Line Post - Pack no: 8606

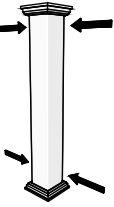

End Post - Pack no: 8607

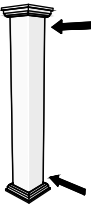

Corner Post - Pack no: 8608

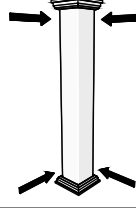

Special Post - Pack no: 8803

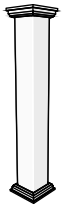

Revisions		
1	14/11/17	Sheet Production - RL
2	06/10/20	Name definition, and layout update - MS
3	10/02/21	Layout update - RL
4	02/02/23	Layout update - LMS
5	---/---/---	...