

Alternative top caps

FD-12 Kystgjerdet 90 with New England top

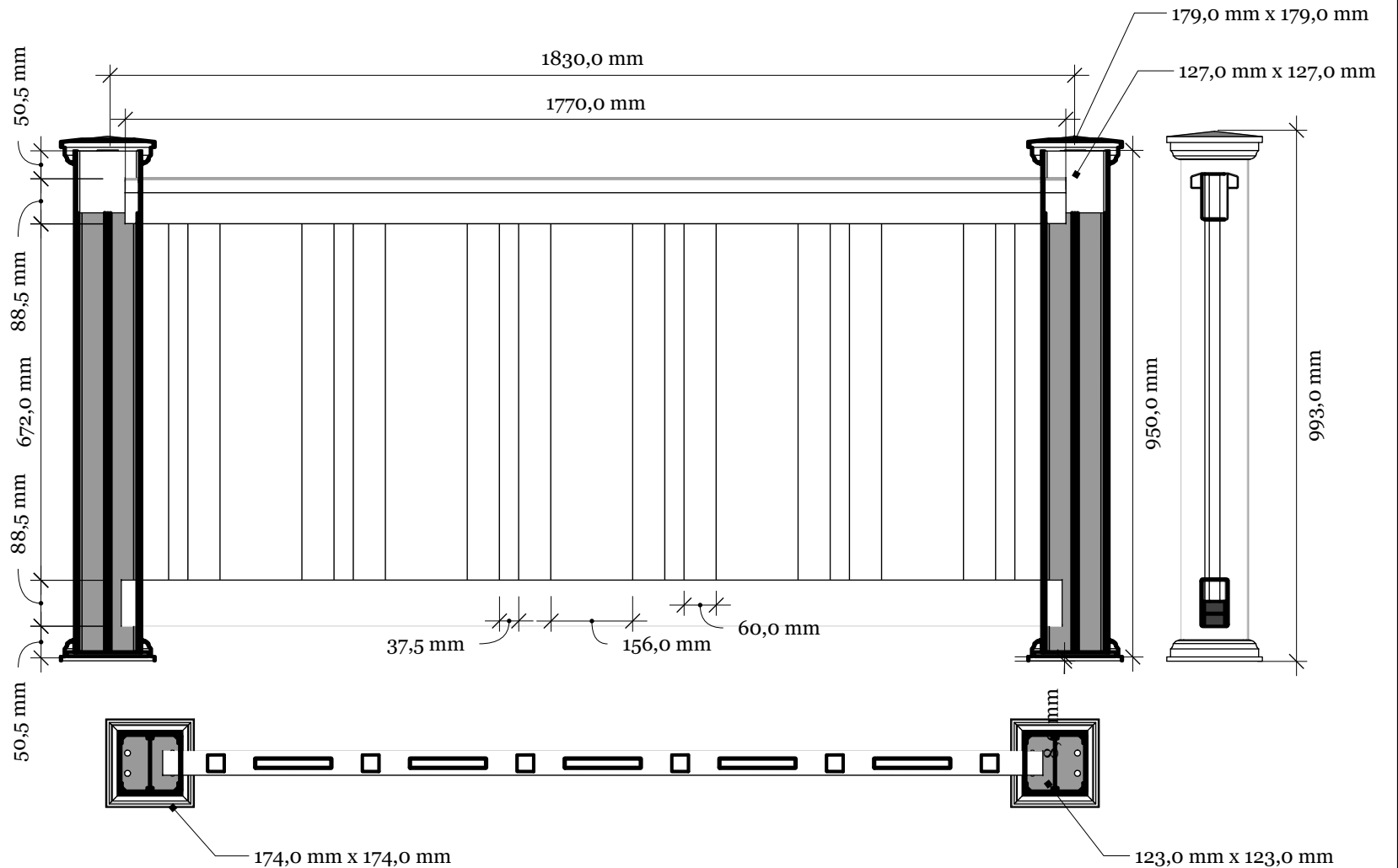
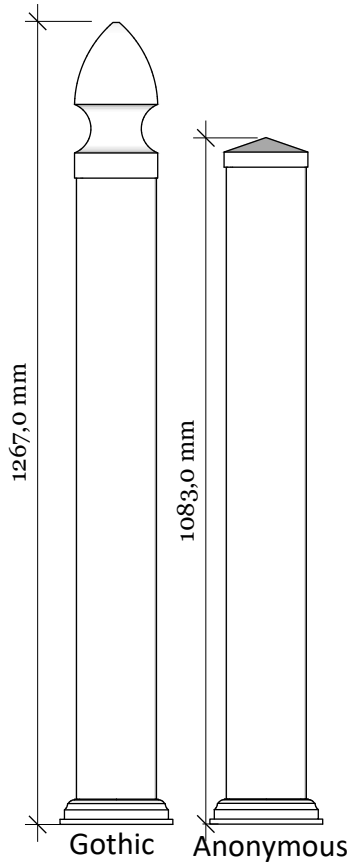

FD-12 Kystgjerdet 90

www.kystgjerdet.com

Revisions

No.	Date	Description
1	14/11/17	Sheet Production - RL
2	06/10/20	Name definition, and layout update - MS
3	10/02/21	Layout update - RL
4	---/---/---	...
5	---/---/---	...

A 03

A

FD-12 Kystgjerdet 90 railing with New England topp

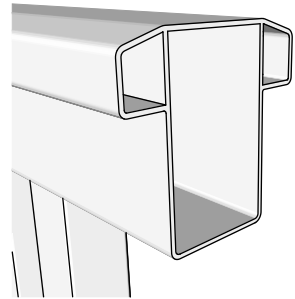

Top rail profile

Rigid aluminum insert in post

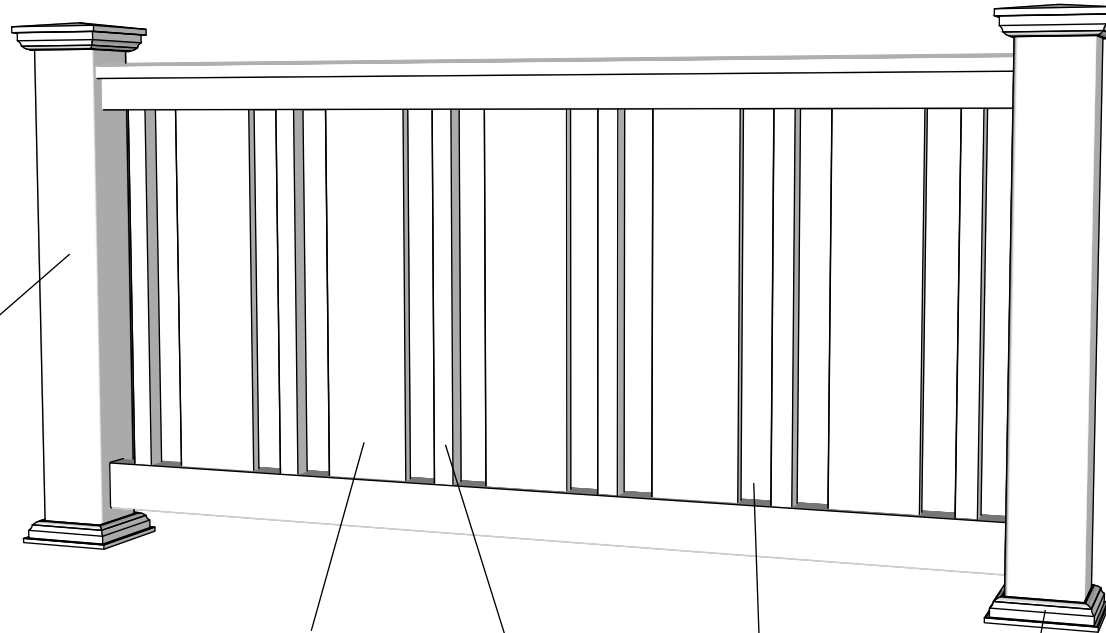
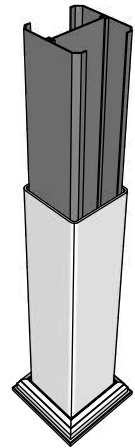

Post
127mm x 127mm

Picket
152mm x 24mm Picket
37,5mm x 37,5mm

Spacing 60mm

Bottom of insert is
123mm x 123mm
8mm thickness of alu

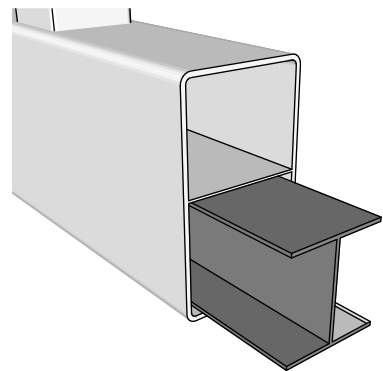

Aluminum profile in
bottom rail to prevent
deflection

Dia = 12mm

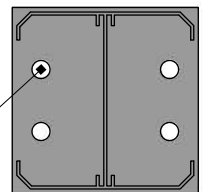

Bottom cover
174mm x 174mm.



FD-12 Kystgjerdet 90

www.kystgjerdet.com

Revisions

No.	Date	Description
1	14/11/17	Sheet Production - RL
2	06/10/20	Name definition, and layout update - MS
3	10/02/21	Layout update - RL
4	___/___/___	...
5	___/___/___	...

03

A

Alt. for component 1:

Art. No: 102300

Art. No: 102300

Art. No: 102303

Alt. for component 2:

Line Post: Art. No: 100800
For pack no: 1200

End Post: Art. No: 100801
For pack no: 1201

Corner Post: Art. No: 100802
For pack no: 1202

Special Post: Art. No: 101500
For pack no: 1203

Component overview for pack no: 1200-1203

1 full section contains:

1. Aluminum insert for post	- Art. No: See alternatives
2. PVC post	- Art. No: See alternatives
3. New England top (if not specified)	- Art. No: 102457
4. Bottom cover	- Art. No: 102449
5. 6 Pickets	- Art. No: 100601
6. Top rail	- Art. No: 100004
7. 5 Pickets	- Art. No: 101700
8. Bottom rail with alu. liner	- Art. No: 100103

Additional posts can be purchased separately:

Line Post - Pack no: 8600

End Post - Pack no: 8601

Corner Post - Pack no: 8602

Special Post - Pack no: 8801

Revisions		
1	14/11/17	Sheet Production - RL
2	06/10/20	Name definition, and layout update - MS
3	10/02/21	Layout update - RL
4	02/02/23	Layout update - LMS
5	--/--/--	...