

Alternative topper

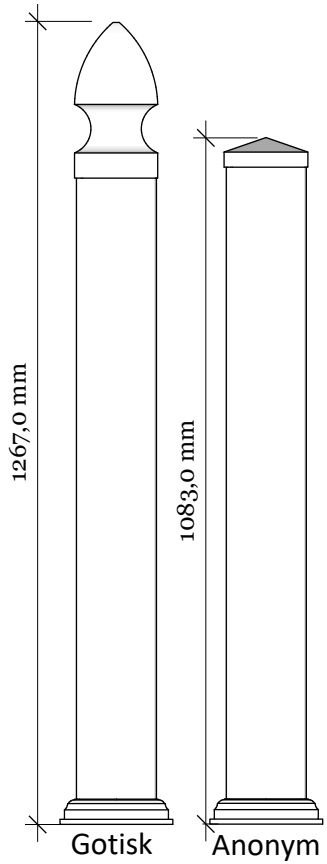

FD-12 Kystgjerdet 120 with New England topp

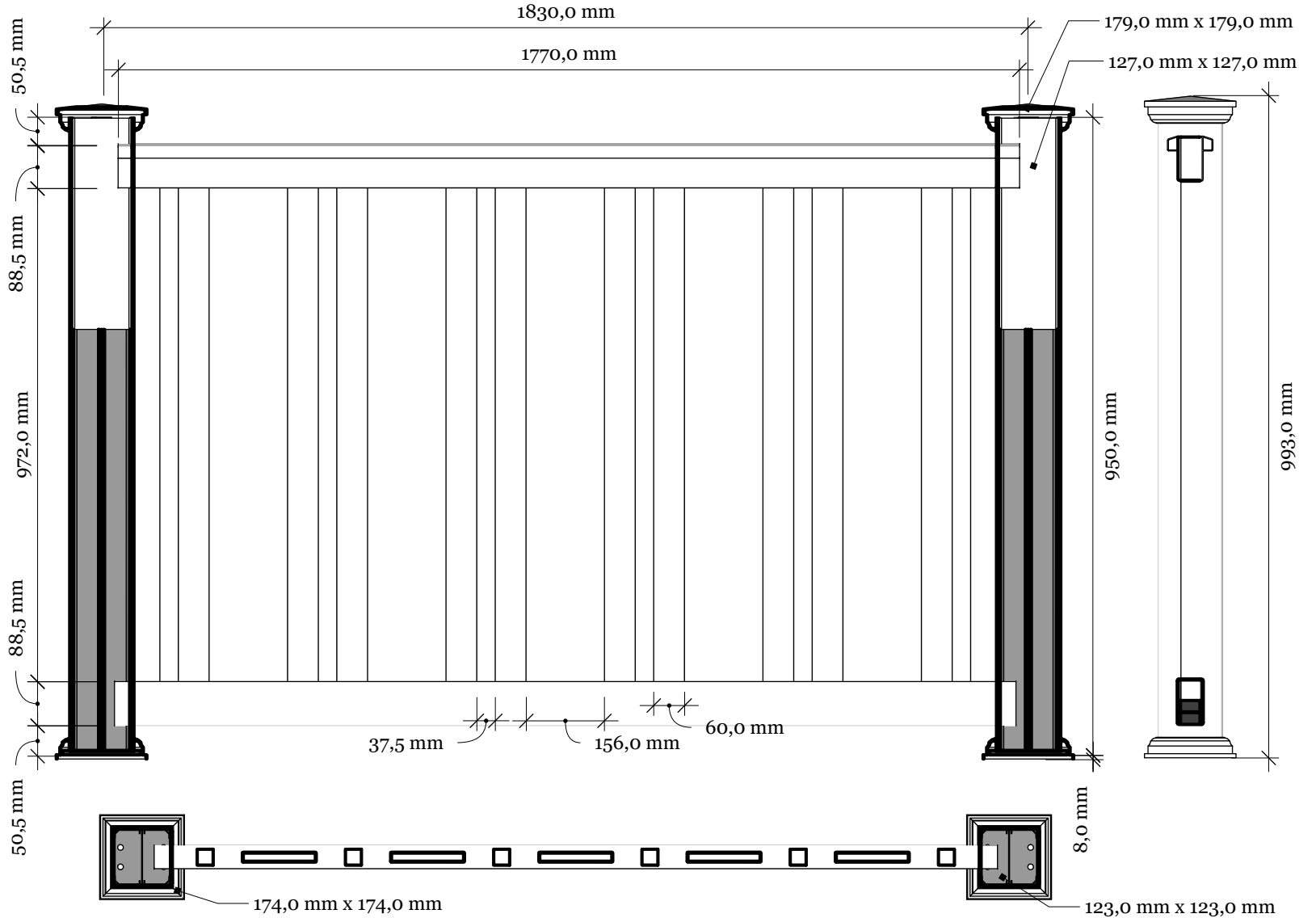

KYSTGJERDET
Kvalitet fremfor kvantitet!

FD-12 Kystgjerdet 120

www.kystgjerdet.com

REVISJONER

	MM/DD/ÅÅ	BEMERKNINGER
1	20 /11/17	Produksjon av datablad
2	30/09/20	Oppdatering av produktnavn + ekstra målsetting
3	10/02/21	Layout update - LMS
4	--/--/--	...
5	--/--/--	...

03

A

FD-12 Kystgjerdet 120 railing with New England top

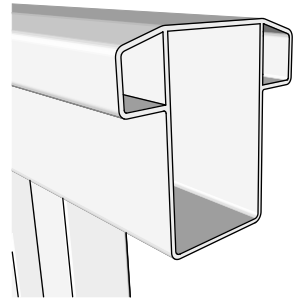

Top rail profile

Rigid aluminum insert in post

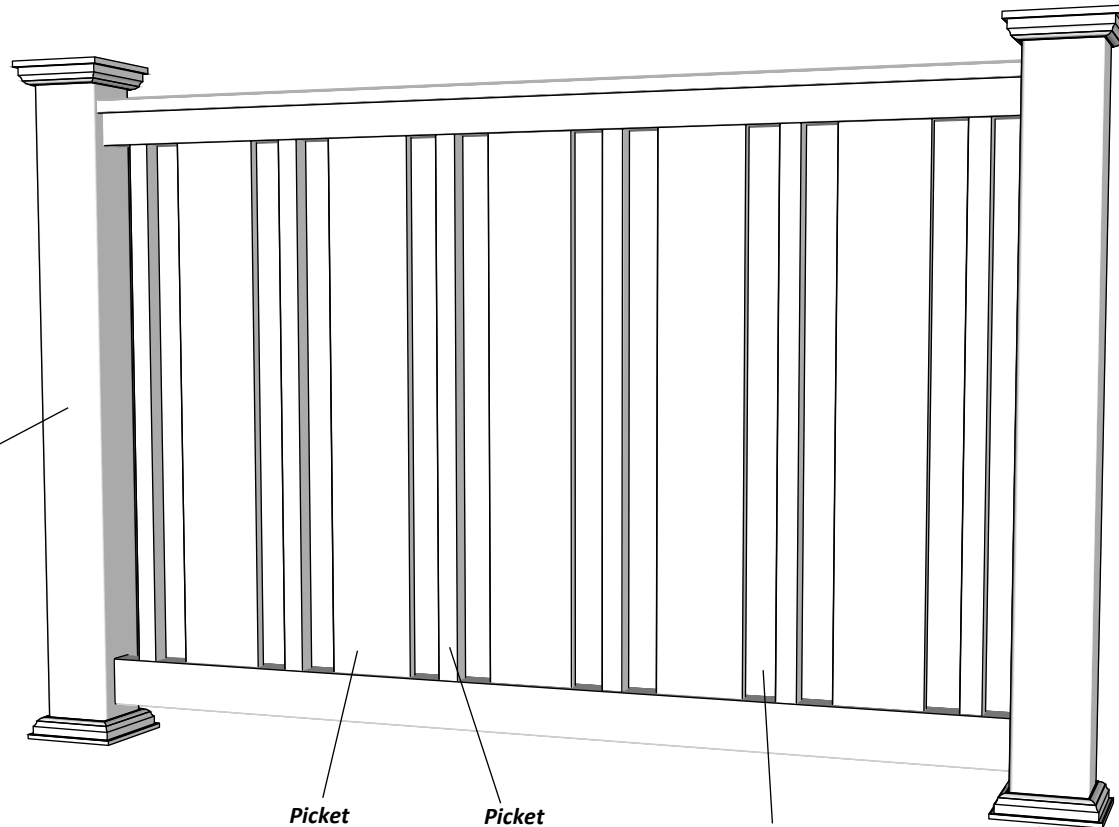
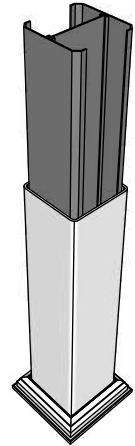

Post
127mm x 127mm

Picket 152mm x 24mm
Picket 37,5mm x 37,5mm

Spacing 60mm

Bottom of insert is
123mm x 123mm
8mm thickness of alu

Aluminum profile in
bottom rail to prevent
deflection

Bottom cover
174mm x 174mm.

Dia = 12mm

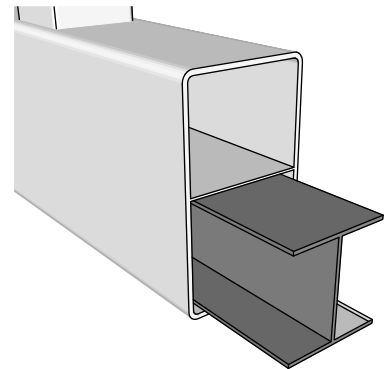
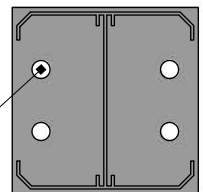

Revisions		
1	14/11/17	Sheet Production - RL
2	06/10/20	Name definition, and layout update - MS
3	10/02/21	Layout update - RL
4	___/___/___	...
5	___/___/___	...

Alt. for component 1:

Art. No: 102300

Art. No: 102300

Art. No: 102303

Alt. for component 2:

Line Post: Art. No: 100831
For pack no: 1222

End Post: Art. No: 100832
For pack no: 1223

Corner Post: Art. No: 100833
For pack no: 1224

Special Post: Art. No: 101506
For pack no: 1225

Component overview for pack no: 1222-1225

1 full section contains:

1. Aluminum insert for post	- Art. No: See alternatives
2. PVC post	- Art. No: See alternatives
3. New England top (if not specified)	- Art. No: 102457
4. Bottom cover	- Art. No: 102449
5. 6 Pickets	- Art. No: 100604
6. Top rail	- Art. No: 100004
7. 5 Pickets	- Art. No: 101702
8. Bottom rail with alu. liner	- Art. No: 100103

Additional posts can be purchased separately:

Line Post - Pack no: 8612

End Post - Pack no: 8613

Corner Post - Pack no: 8614

Special Post - Pack no: 8807



FD-12 Kystgjerdet 120

www.kystgjerdet.com

Revisions		
1	14/11/17	Sheet Production - RL
2	06/10/20	Name definition, and layout update - MS
3	10/02/21	Layout update - RL
4	02/02/23	Layout update - LMS
5	--/--/--	...

A 04