

Alternative top caps

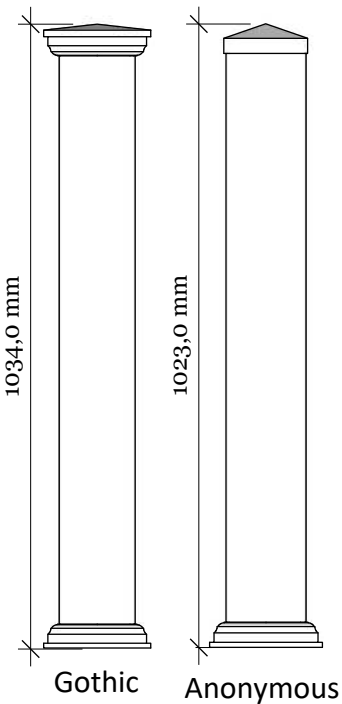

FC-5 Langefjell 100 with Gothic top

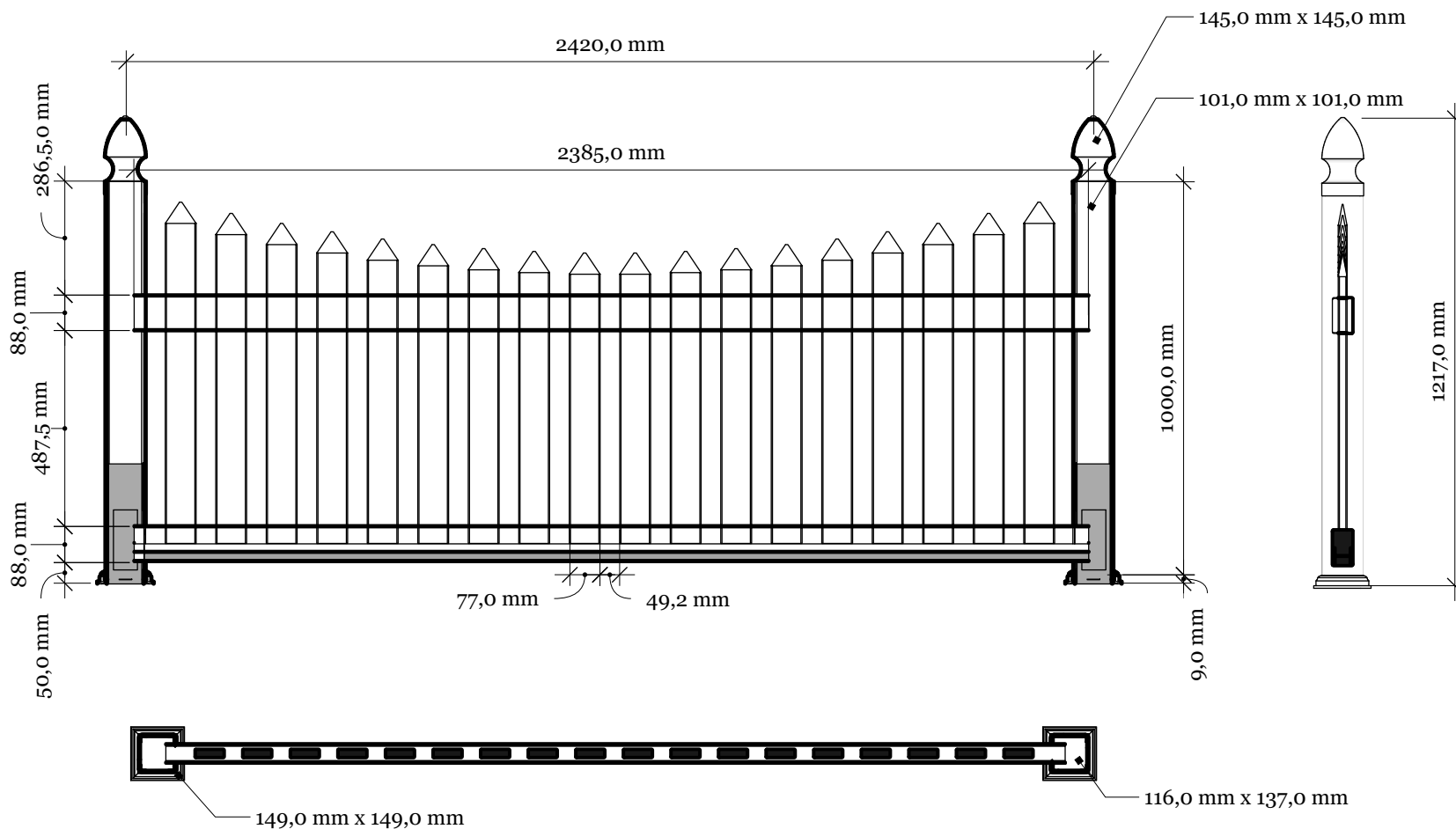

Revisions		
1	14/11/17	Sheet Production - RL
2	06/10/20	Name definition, and layout update - MS
3	10/02/21	Layout update - RL
4	---/---/---	...
5	---/---/---	...

# FC-5 Langefjell 100 Fence with Gothic top

Galvanized steel insert in post

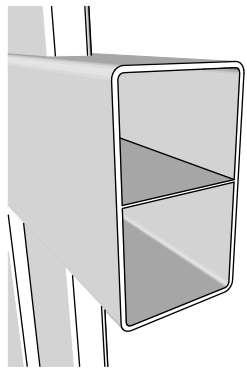

Top rail profile

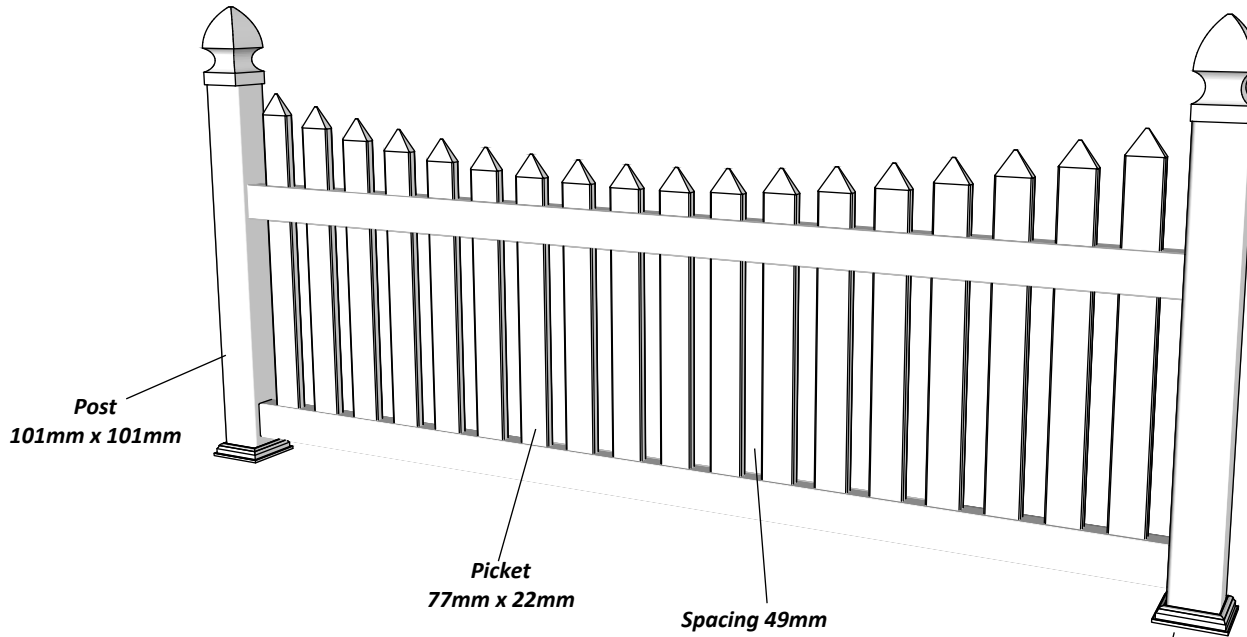
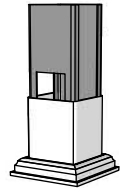

Post  
101mm x 101mm

Picket  
77mm x 22mm

Spacing 49mm

Bottom cover  
149mm x 149mm.

Dia = 12mm

Bottom of insert is  
123mm x 123mm  
8mm thickness of alu

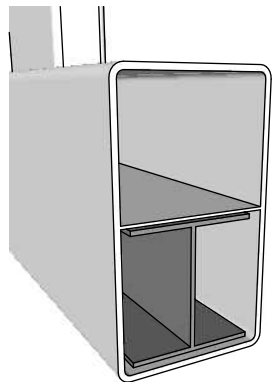
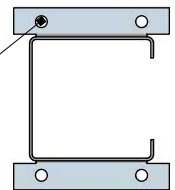

Aluminum profile in  
bottom rail to prevent  
deflection



FC-5 Langefjell 100

www.kystgjerdet.com

Revisions		
1	14/11/17	Sheet Production - RL
2	06/10/20	Name definition, and layout update - MS
3	10/02/21	Layout update - RL
4	___/___/___	...
5	___/___/___	...

A 03

**Component 1:**

**Art. No: 102311**

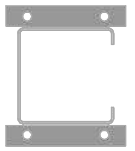

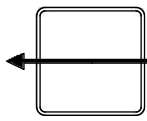

---

**Alt. for component 2:**

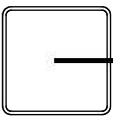
 **Line Post: Art. No: 102106**  
For pack no: 3111

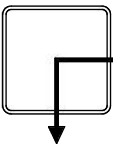
 **End Post: Art. No: 102107**  
For pack no: 3112

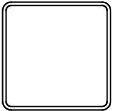
 **Corner Post: Art. No: 102108**  
For pack no: 3113

 **Special Post: Art. No: 102121**  
For pack no: 3114

**Component overview for pack no: 3111-3114**

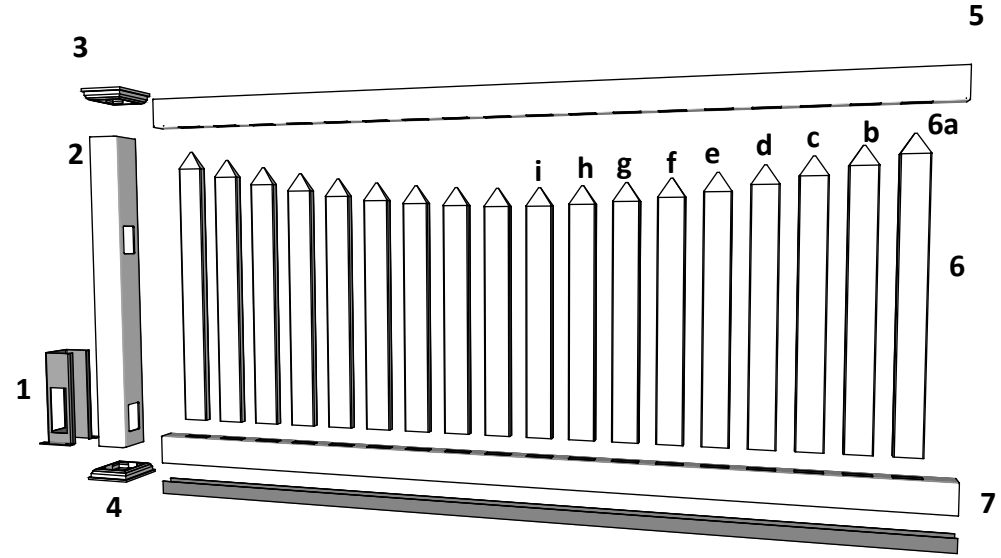

**1 full section contains:**

1. Steel insert for post	- Art. No: 102311
2. PVC post	- Art. No: See alternatives
3. New England top (as standard)	- Art. No: 102457
4. Bottom cover	- Art. No: 102449
5. Top rail	- Art. No: 100301
6. 13 Pickets - Art. No: 6a- 102000, b- 102009, c- 102010, d- 102011, e- 102012, f- 102013, g - 102014, h- 102008,i- 102016	
7. Bottom rail with alu. liner	- Art. No: 100105

**Additional posts can be purchased separately:**

Line Post - Pack no: 8852

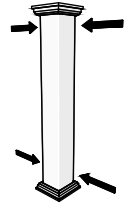

End Post - Pack no: 8853

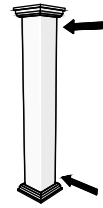

Corner Post - Pack no: 8854

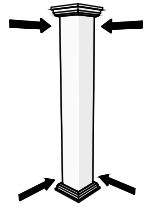

Special Post - Pack no: 8857

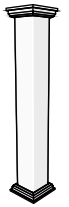

Revisions		
1	14/11/17	Sheet Production - RL
2	06/10/20	Name definition, and layout update - MS
3	10/02/21	Layout update - RL
4	02/02/23	Layout update - LMS
5	--/--/--	...