

Alternative top caps

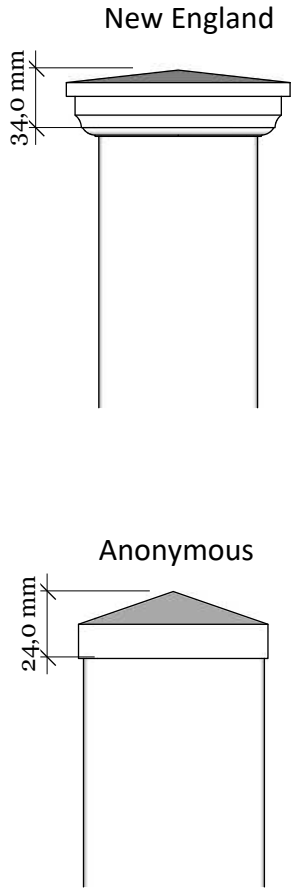

FB-5 Tind 100 with Gothic top

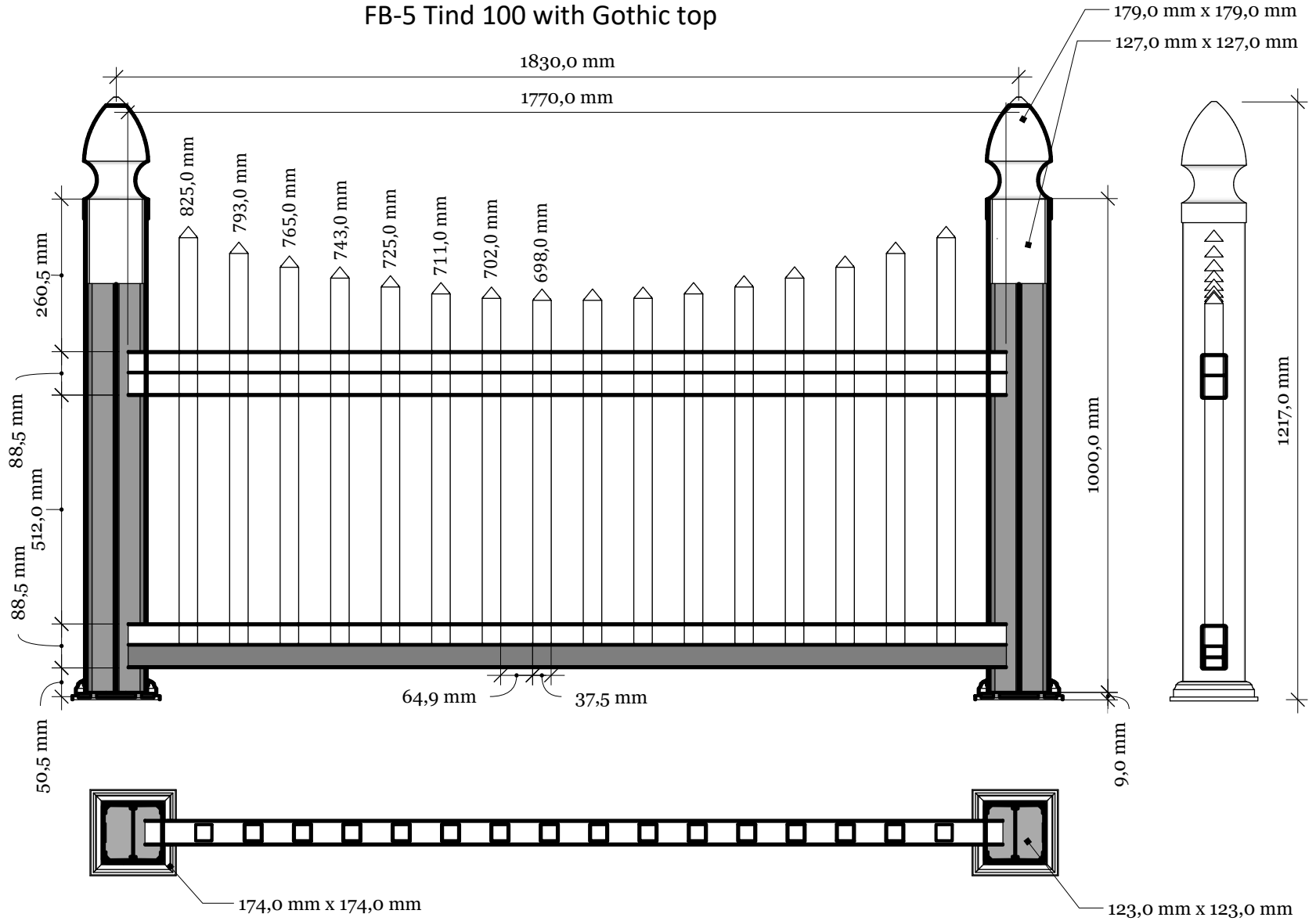

Revisions		
1	14/11/17	Sheet Production - RL
2	06/10/20	Name definition, and layout update - MS
3	10/02/21	Layout update - RL
4	---/---/---	...
5	---/---/---	...

FB-5 Tind 100 Fence with Gothic top

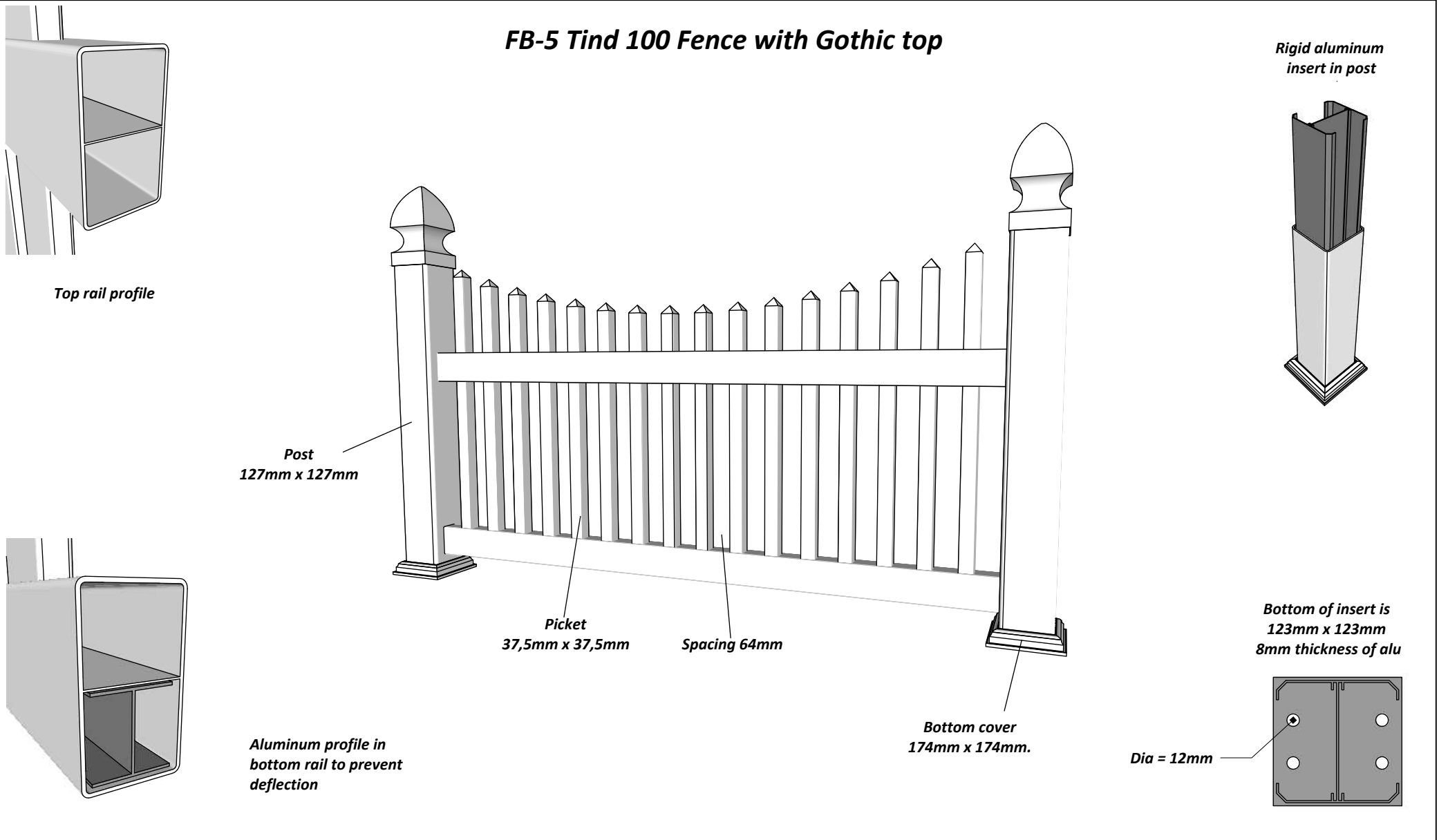

KYSTGJERDET

FB-5 Tind 100
www.kystgjerdet.com

Revisions		
1	14/11/17	Sheet Production - RL
2	06/10/20	Name definition, and layout update - MS
3	10/02/21	Layout update - RL
4	___/___/___	...
5	___/___/___	...

03

A

Alt. for component 1:

Art. No: 102300

Art. No: 102300

Art. No: 102303

Alt. for component 2:

Line Post: Art. No: 100900
For pack no: 3300

End Post: Art. No: 100901
For pack no: 3301

Corner Post: Art. No: 100902
For pack no: 3302

Special Post: Art. No: 100501
For pack no: 3303

Component overview for pack no: 3300-3303

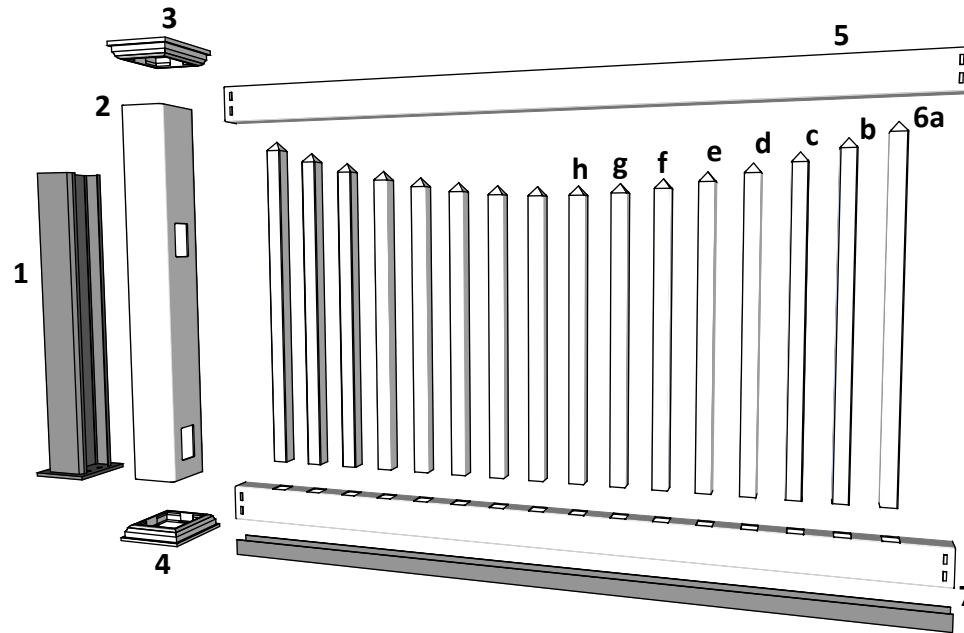

1 full section contains:

1. Aluminum insert for post	- Art. No: See alternatives
2. PVC post	- Art. No: See alternatives
3. New England top (as standard)	- Art. No: 102457
4. Bottom cover	- Art. No: 102449
5. Top rail	- Art. No: 100300
6. 16 Pickets - Art. No: 6a- 101614, b- 101615, c- 101616, d- 101617, e- 101618, f- 101619, g- 101620, h- 101630	
7. Bottom rail with alu. liner	- Art. No: 100101

Additional posts can be purchased separately:

Line Post - Pack no: 8638

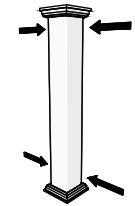

End Post - Pack no: 8639

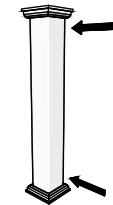

Corner Post - Pack no: 8640

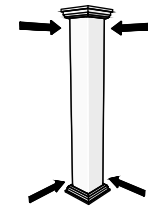

Special Post - Pack no: 8802

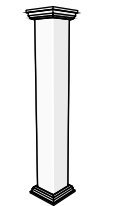

Revisions

No.	Date	Description
1	14/11/17	Sheet Production - RL
2	06/10/20	Name definition, and layout update - MS
3	10/02/21	Layout update - RL
4	02/02/23	Layout update - LMS
5	---/---/---	...