

Alternative top caps

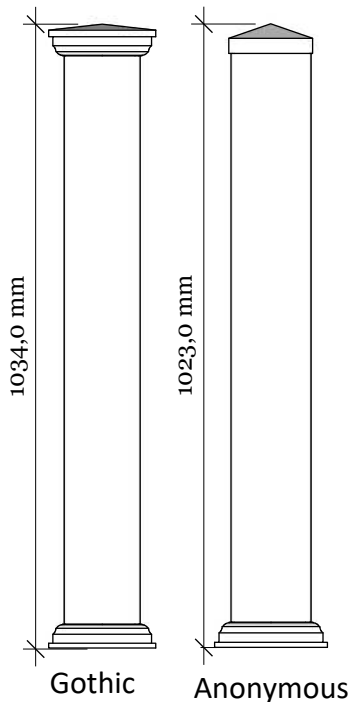

FB-5 Langetind 100 with Gothic top

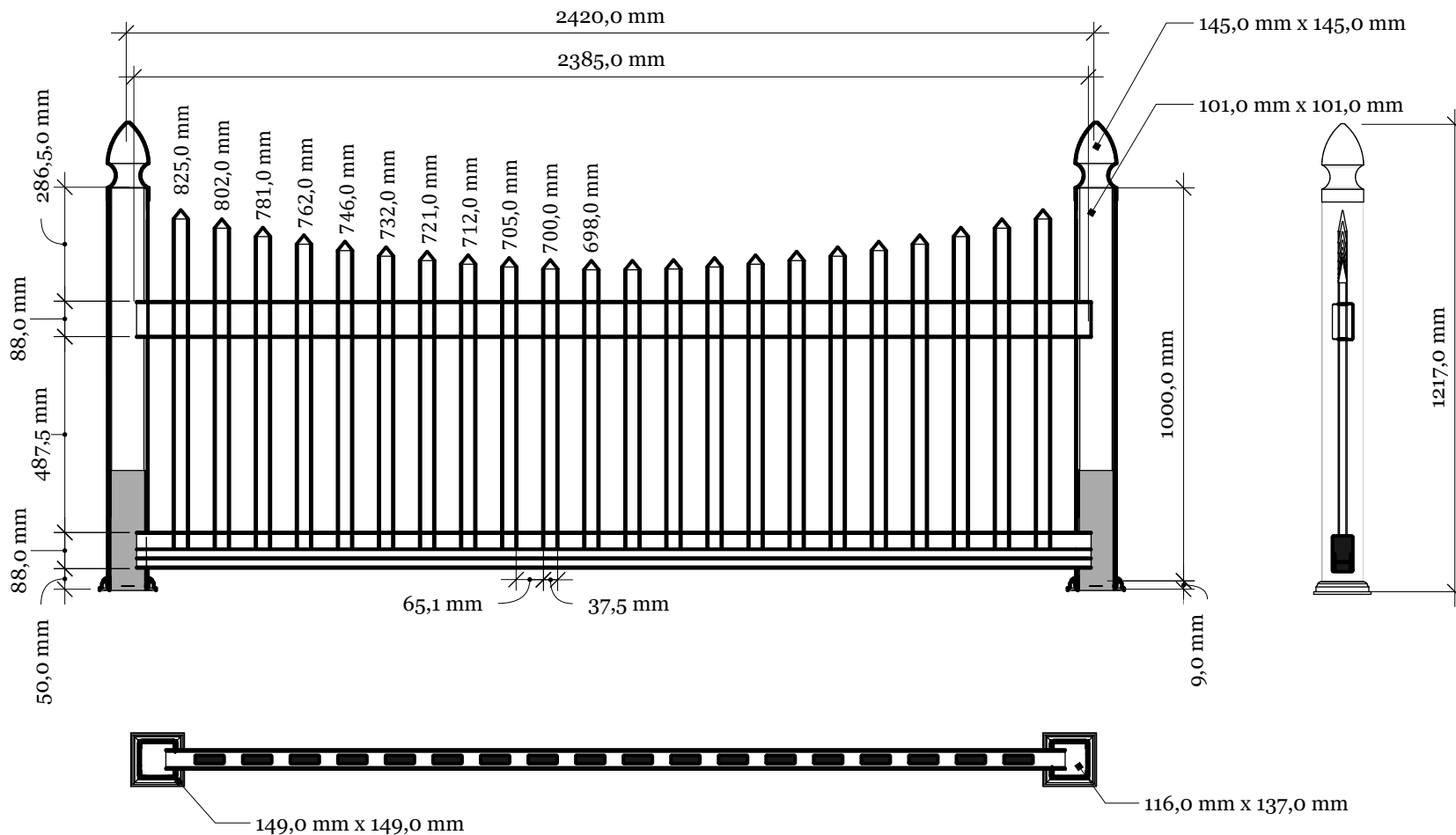

Revisions		
1	14/11/17	Sheet Production - RL
2	06/10/20	Name definition, and layout update - MS
3	10/02/21	Layout update - RL
4	---/---/---	...
5	---/---/---	...

FB-5 Langetind 100 Fence with Gothic topp

30cm høy
galvanisert stålinsats

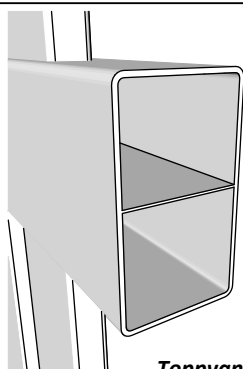

Toppvange

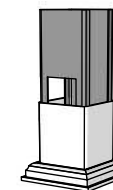

Stolper måler
101mm x 101mm.

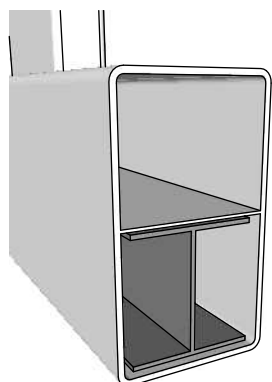

Aluminium profil
i bunnvange
for å forhindre nedbøying.

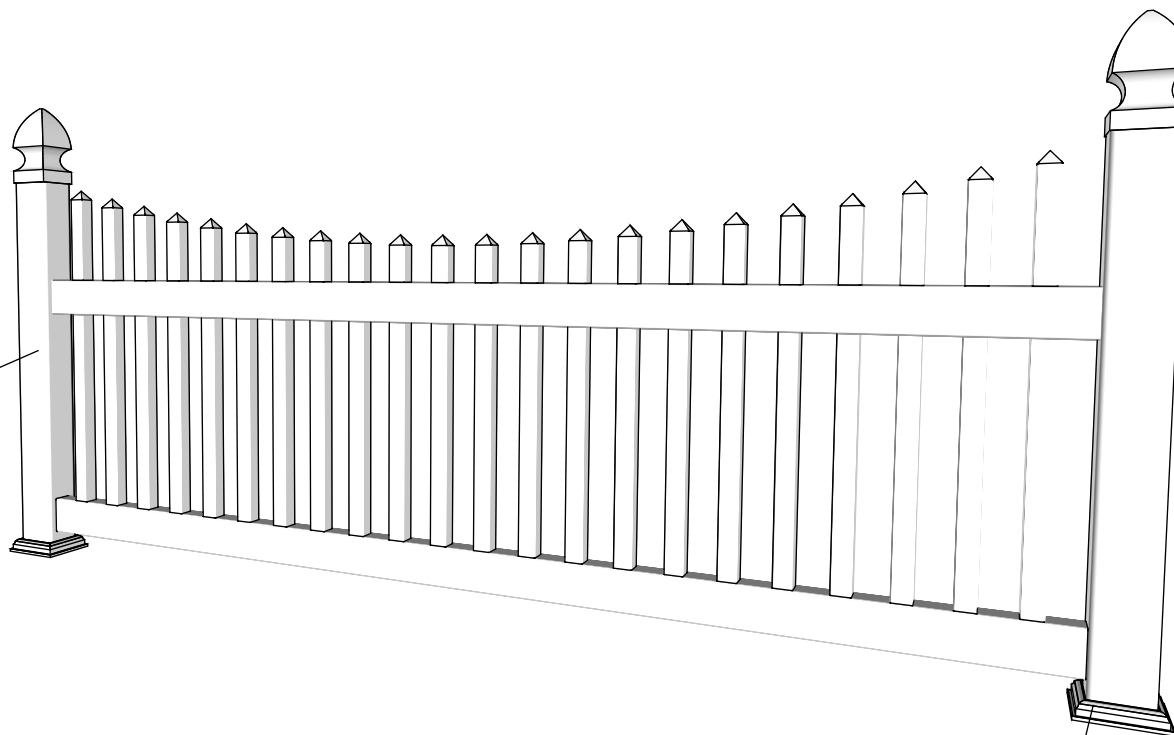

Bunnplate stål profil
måler 116mm x 137mm.
1,5mm tykk.

Stolpekrans måler
149mm x 149mm.

Ø = 12mm

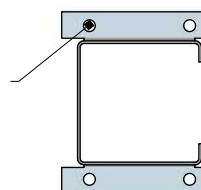

KYSTGJERDET

Kvalitet fremfor kvantitet!

FB-5 Langetind 100

www.kystgjerdet.com

REVISJONER

	MM/DD/ÅÅ	BEMERKNINGER
1	19/11/17	Produksjon av datablad
2	01/10/20	Oppdatering av produktnavn, + ekstra målsetting
3	---/---/---	...
4	---/---/---	...
5	---/---/---	...

A 02

A

Component 1:

Art. No: 102311

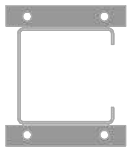

Alt. for component 2:

Line Post: Art. No: 102106
For pack no: 3111

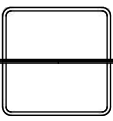

End Post: Art. No: 102107
For pack no: 3112



Corner Post: Art. No: 102108
For pack no: 3113



Special Post: Art. No: 102121
For pack no: 3114



Component overview for pack no: 3111-3114

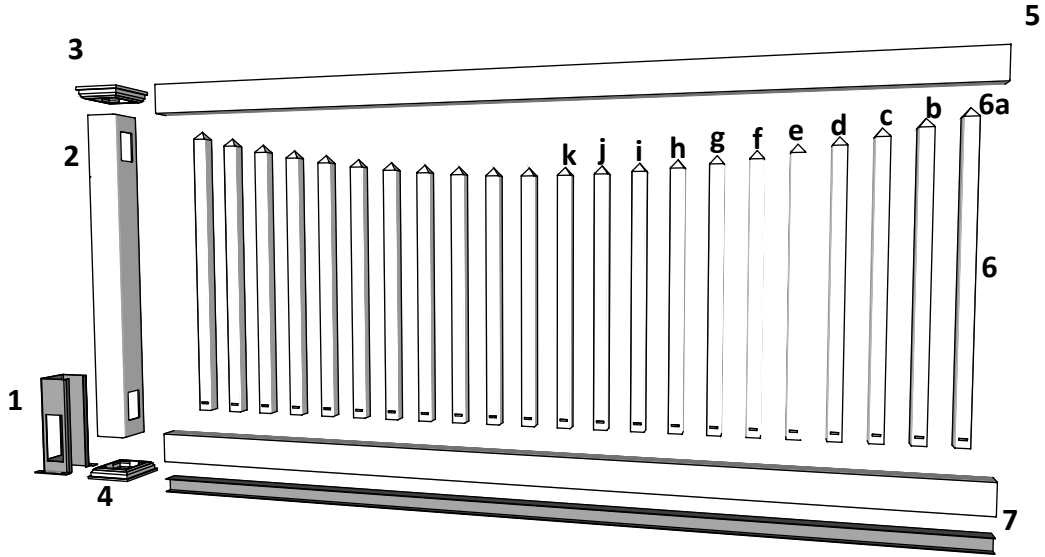

1 full section contains:

1. Steel insert for post	- Art. No: 102311
2. PVC post	- Art. No: See alternatives
3. New England top (as standard)	- Art. No: 102457
4. Bottom cover	- Art. No: 102449
5. Top rail	- Art. No: 100328
6. 22 Pickets - Art. No: 6a- 101614, b- 101621, c- 101622, d- 101623, e- 101624, f- 101625, g - 101626, h- 101627, i- 101628, j- 101629, k- 101630	
7. Bottom rail with alu. liner	- Art. No: 100115

Additional posts can be purchased separately:

Line Post - Pack no: 8852

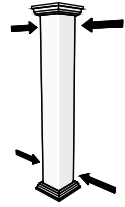

End Post - Pack no: 8853

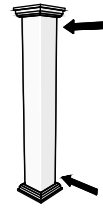

Corner Post - Pack no: 8854

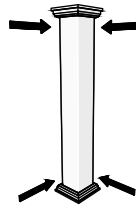

Special Post - Pack no: 8857



Revisions		
1	14/11/17	Sheet Production - RL
2	06/10/20	Name definition, and layout update - MS
3	10/02/21	Layout update - RL
4	02/02/23	Layout update - LMS
5	--/--/--	...