

Alternative top caps

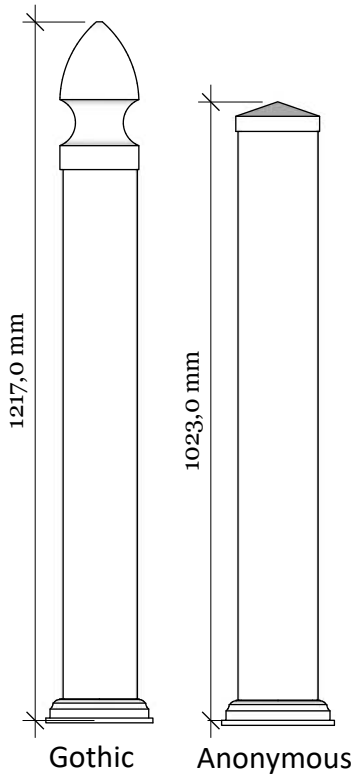

FB-3 Langesund 100 with New England top

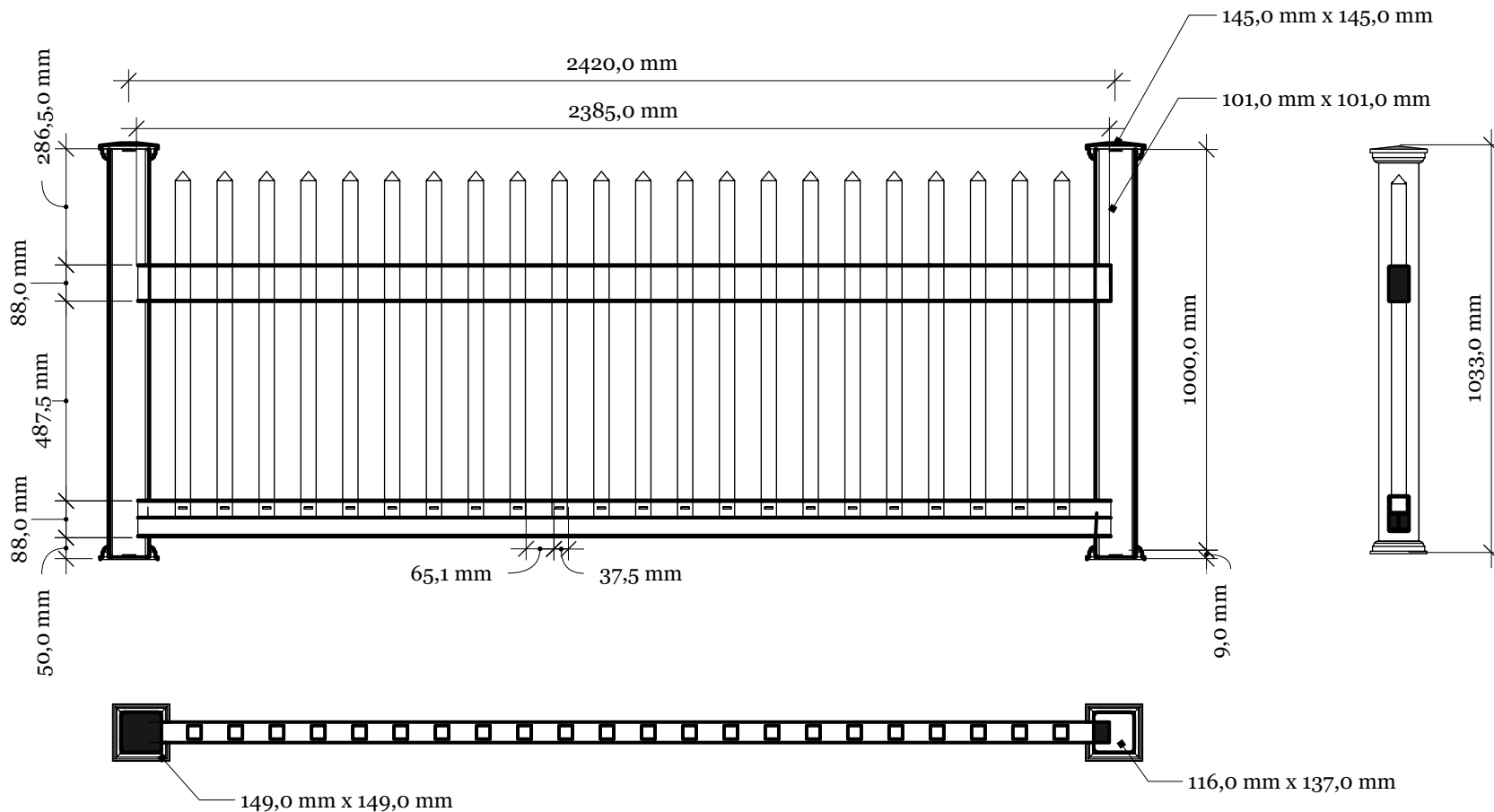

Revisions		
1	14/11/17	Sheet Production - RL
2	06/10/20	Name definition, and layout update - MS
3	10/02/21	Layout update - RL
4	---/---/---	...
5	---/---/---	...

FB-3 Langesund 100 Fence with New England top

Galvanized steel insert in post

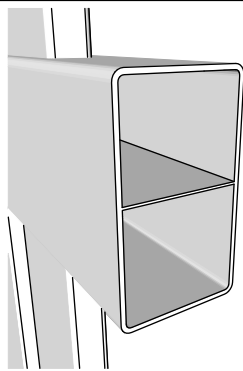

Top rail profile

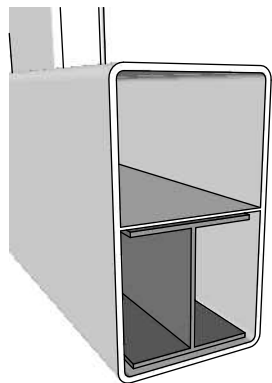
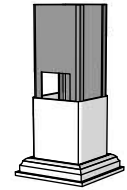

Aluminum profile in bottom rail to prevent deflection

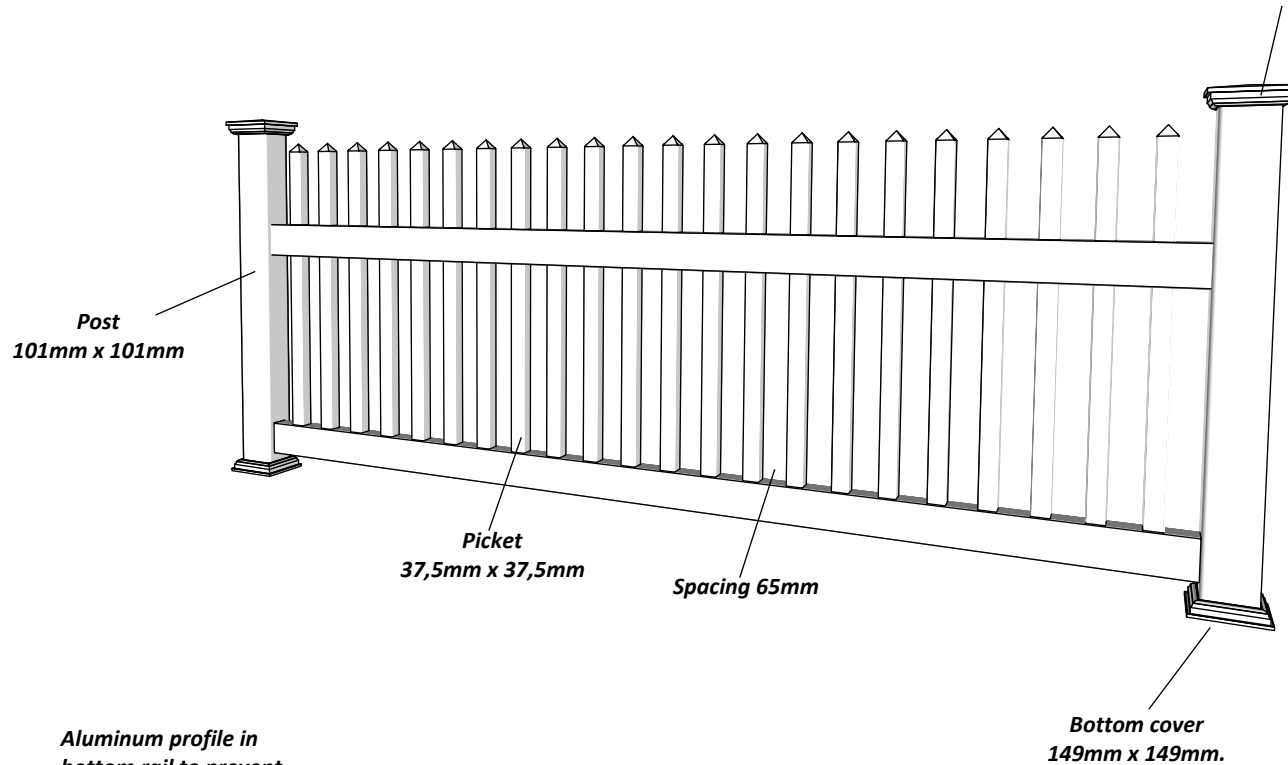

Bottom of insert is 123mm x 123mm 8mm thickness of alu

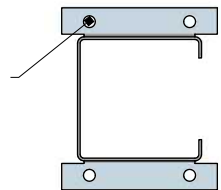

KYSTGJERDET

FB-3 Langesund 100

www.kystgjerdet.com

Revisions

No.	Date	Description
1	14/11/17	Sheet Production - RL
2	06/10/20	Name definition, and layout update - MS
3	10/02/21	Layout update - RL
4	___/___/___	...
5	___/___/___	...

A 03

A

Component 1:

Art. No: 102311

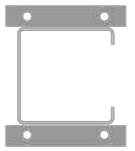

Alt. for component 2:

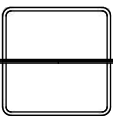
 **Line Post: Art. No: 102106**
For pack no: 3211

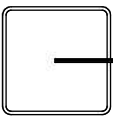
 **End Post: Art. No: 102107**
For pack no: 3212

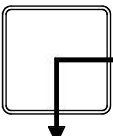
 **Corner Post: Art. No: 102108**
For pack no: 3213

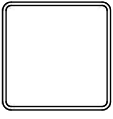
 **Special Post: Art. No: 102121**
For pack no: 3214

Component overview for pack no: 3211-3214

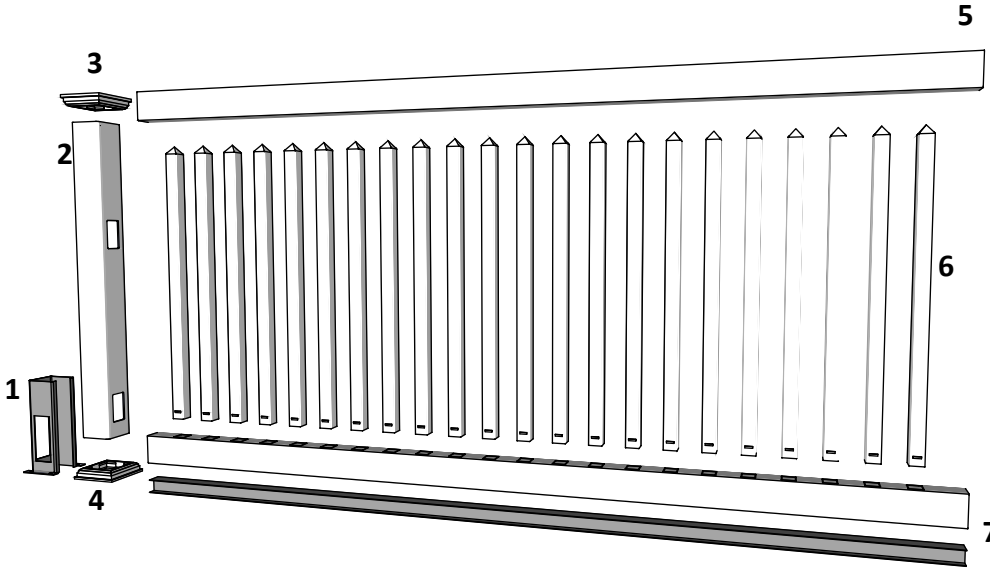

1 full section contains:

1. Steel insert for post	- Art. No: 102311
2. PVC post	- Art. No: See alternatives
3. New England top (as standard)	- Art. No: 102404
4. Bottom cover	- Art. No: 102450
5. Top rail	- Art. No: 100328
6. 22 Pickets	- Art. No: 101614
7. Bottom rail with alu. liner	- Art. No: 100115

Additional posts can be purchased separately:

Line Post - Pack no: 8852

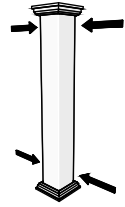

End Post - Pack no: 8853

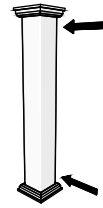

Corner Post - Pack no: 8854

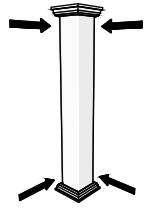

Special Post - Pack no: 8857

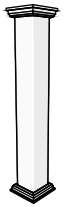

Revisions		
1	14/11/17	Sheet Production - RL
2	06/10/20	Name definition, and layout update - MS
3	10/02/21	Layout update - RL
4	02/02/23	Layout update - LMS
5	--/--/--	...