

Alternative top caps

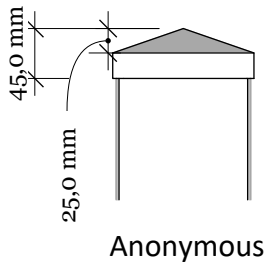

FA-3D Blest Diagonal 180-95 with New England top

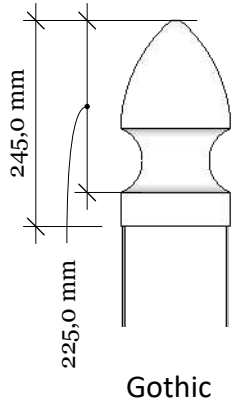
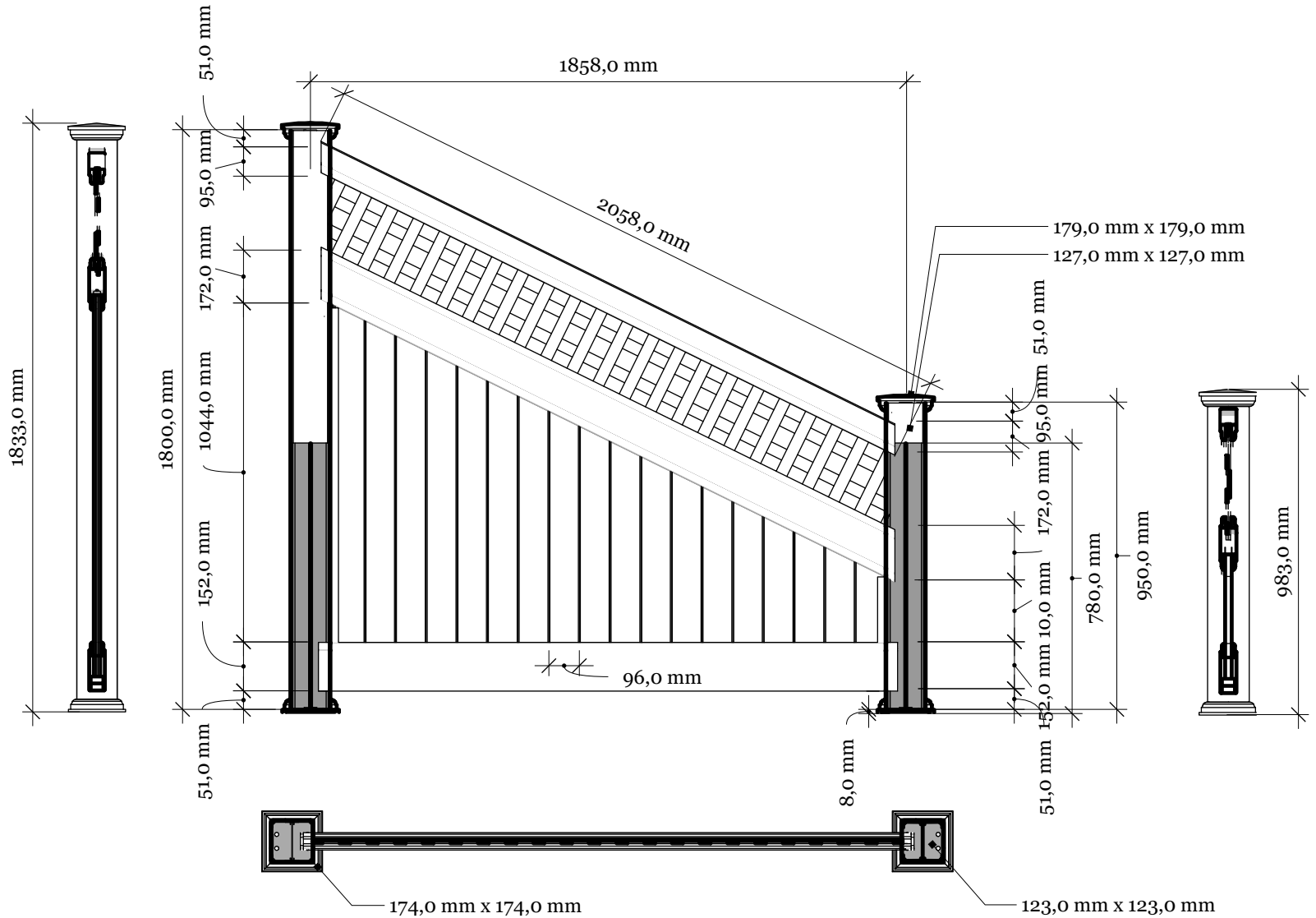

FA-3D Blest Diagonal 180-95

www.kystgjerdet.com

Revisions		
	MM/DD/YY	Notes
1	14/11/17	Sheet Production - RL
2	06/10/20	Name definition, and layout update - MS
3	10/02/21	Layout update - LMS
4	---/---/---	...
5	---/---/---	...

03

A

FA-3D Blest Diagonal 180-95 with New England top

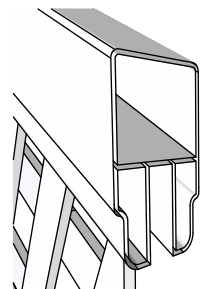

Top rail profile

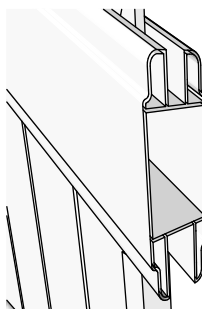

Middle rail profile

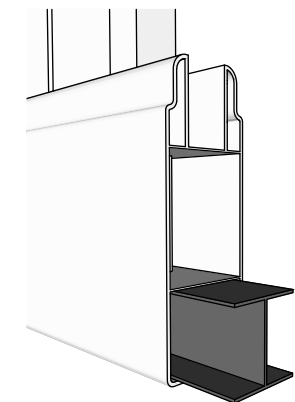

Aluminum profile in bottom rail to prevent deflection

Post
127mm x 127mm

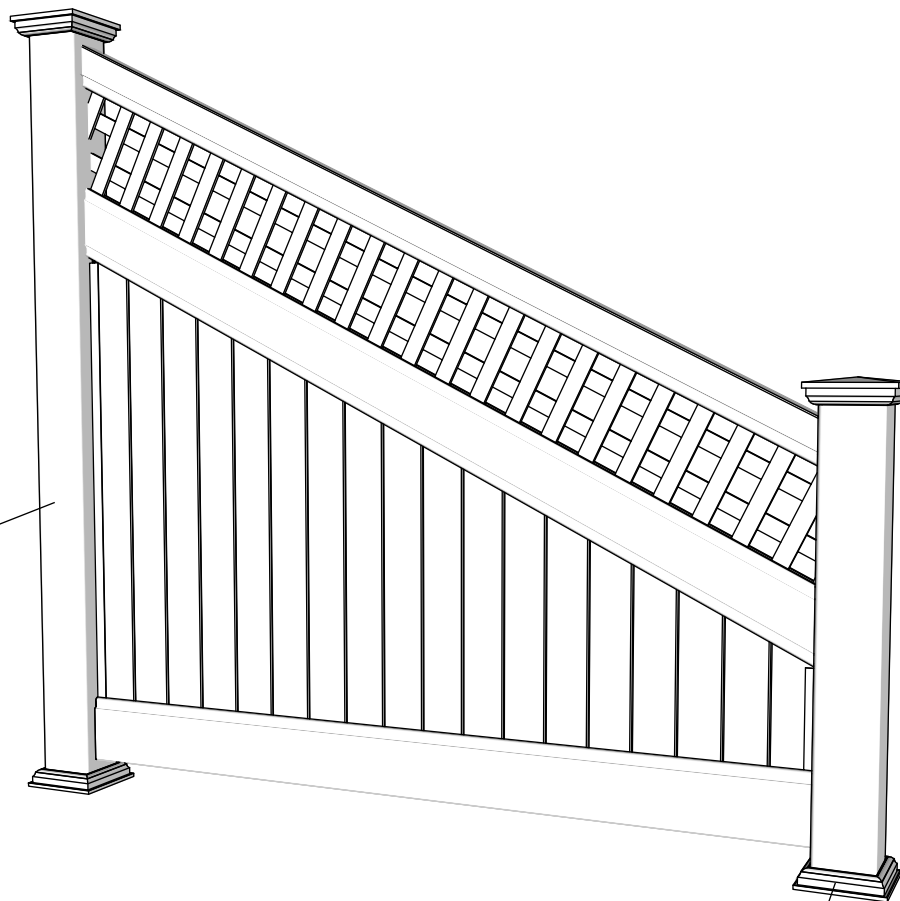

Bottom cover
174mm x 174mm.

Rigid aluminum insert in post

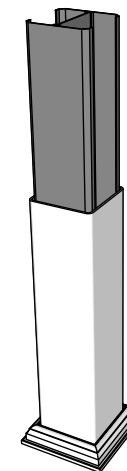

Bottom of insert is
123mm x 123mm
8mm thickness of alu

Dia = 12mm

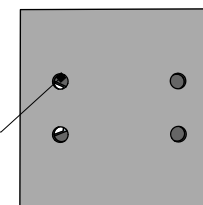

FA-3D Blest Diagonal 180-95

www.kystgjerdet.com

Revisions

	MM/DD/YY	Notes
1	14/11/17	Sheet Production - RL
2	06/10/20	Name definition, and layout update - MS
3	10/02/21	Layout update - LMS
4	___/___/___	...
5	___/___/___	...

A 03

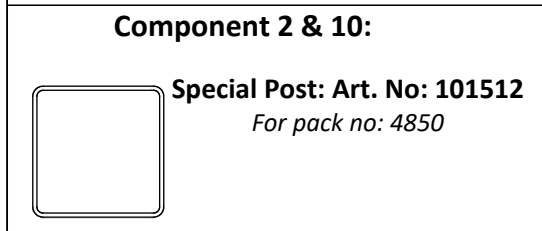
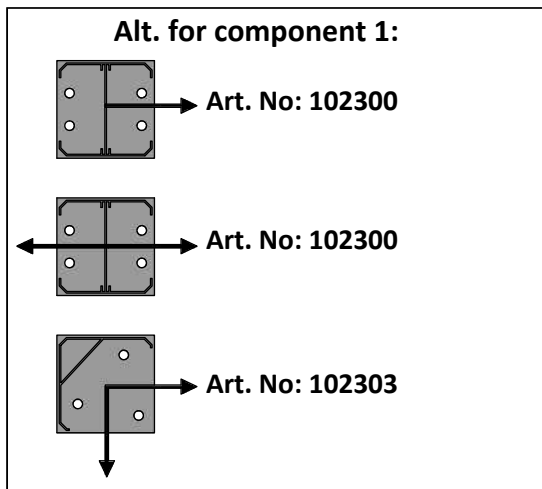

Component overview for pack no: 4850

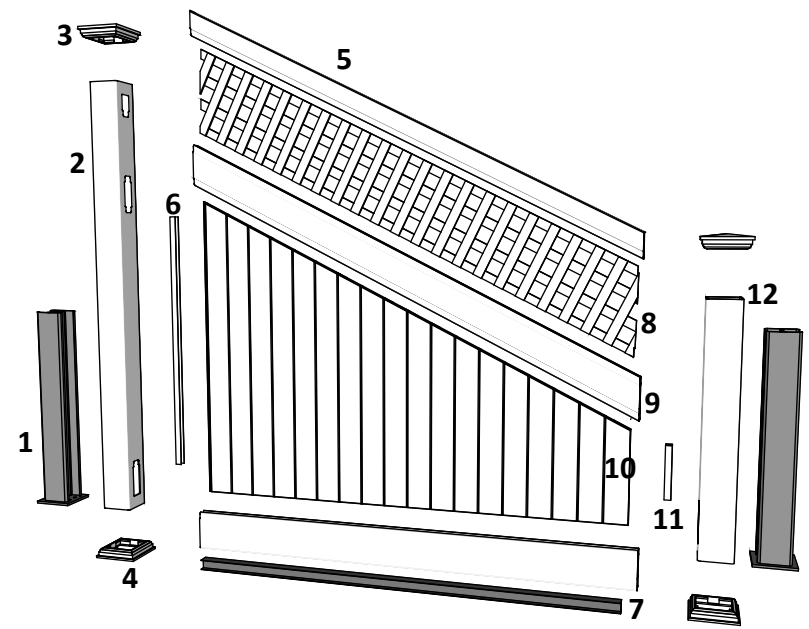

1 full section contains:

1. Aluminum inserts for posts	- Art. No: See alternatives
2. PVC post (tall)	- Art. No: 101512
3. New England top (as standard)	- Art. No: 102457
4. Bottom cover	- Art. No: 102449
5. Top rail	- Art. No: 100706
6. Endlists for panel (tall)	- Art. No: 101829
7. Bottom rail with alu. liner	- Art. No: 100400
8. Lattice	- Art. No: 101909
9. Middle rail	- Art. No: 100606
10. Panel	- Art. No: 102224
11. Endlists for panel (short)	- Art. No: 101828
12. PVC post (short)	- Art. No: 101500

Additional posts can be purchased separately:



FA-3D Blest Diagonal 180-95

www.kystgjerdet.com

Revisions		
1	14/11/17	Sheet Production - RL
2	06/10/20	Name definition, and layout update - MS
3	10/02/21	Layout update - RL
4	02/03/23	Layout update - LMS
5	--/--/--	...

A 04